

KX-14CP1

SERVICE MANUAL

AEP Model

Chassis No. SCC-667A-A

UK Model

Chassis No. SCC-666A-A

French Model

Chassis No. SCC-672A-A



1085

May, 1985

SPECIFICATIONS

Picture tube Fine-pitch Trinitron tube
 13-inch picture measured diagonally
 14-inch picture tube measured diagonally

Inputs/outputs

	Type	Video	Audio
VIDEO IN	Phono jack	1 V p-p, 75 ohms unbalanced, sync negative, 1 kilohm	436 mV rms (100% modulation) 47 kilohms
	BNC type		

ANALOG MULTI/ANALOGIQUE RGB input (21-pin)

See "Signal assignment".

DIGITAL RGB input (8 pin)

See "Signal assignment".

Power requirements 110-240 V AC, 50/60 Hz

Power consumption 85 W (max.)

Dimensions Approx. 385 x 342 x 434 mm (w/h/d)
 (15 1/8 x 13 1/2 x 17 1/8 inches)
 incl. projecting parts and controls

Weight Approx. 12.8 kg (28 lb 5 oz)

Accessories supplied Foot (2)

While the information given is true at the time of printing, small production changes in the course of our company's policy of improvement through research and design might not necessarily be indicated in the specifications. We would ask you to check with your appointed Sony dealer if clarification of any point is required.

SIGNAL ASSIGNMENT

ANALOG MULTI/ANALOGIQUE RGB input connector

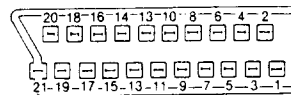

21-pin SCART connector in accordance with the requirements of CENELEC standard

Pin No.	Signal
1	Audio (B) output
2	Audio (B) input
3	Audio (A) output
4	Earth
5	Earth
6	Audio (A) input
7	Blue input 0.7 Vp-p 75 ohms
8	N.C.
9	Earth
10	N.C.
11	Green input 0.7 Vp-p 75 ohms
12	N.C.
13	Earth
14	Earth
15	Red input 1 Vp-p 75 ohms
16	Blanking input
17	N.C.
18	Earth
19	Video output 1V p-p 75 ohms
20	Video input 1 Vp-p 75 ohms
21	Earth



TRINITRON®
 COLOR MONITOR
SONY®

MON

DIGITAL RGB input connector

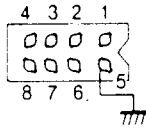

Pin. No.	Signal	Signal level
1	Intensity input	High: * Low: Half tone TTL level
2	Red input	Positive polarity TTL level
3	Green input	
4	Blue input	
5	Ground	—
6	Ground	—
7	H. sync input	TTL level
8	V. sync input	

*When connecting a microcomputer with which + 12 V DC is applied to 1 pin, use a connector with the 1 pin opened. Otherwise the protective Zener diode may be damaged.

TABLE OF CONTENTS

<u>Section</u>	<u>Title</u>	<u>Page</u>	<u>Section</u>	<u>Title</u>	<u>Page</u>
1. GENERAL			5. DIAGRAMS		
1-1.	Location and Function of Controls	4	5-1.	Circuit Boards Location	23
1-2.	Applications with Other Optional Equipment	7	5-2.	Block Diagram	23
1-3.	Features	10	5-3.	Semiconductors	28
2. DISASSEMBLY			5-4.	Schematic Diagrams	29
2-1.	Back Cover Removal	11	5-5.	Printed Wiring Boards	37
2-2.	F Board Removal	11	6. EXPLODED VIEWS		
2-3.	Checking for D Board	12	6-1.	Rear Cover	43
2-4.	Checking for B Board	12	6-2.	CRT	44
2-5.	Removal of Anode Cap	12	7. ELECTRICAL PARTS LIST		45
2-6.	Picture Tube Removal	13			
3. SET-UP ADJUSTMENTS					
3-1.	Beam Landing	14			
3-2.	Convergence	15			
3-3.	Focus (RV701)	16			
3-4.	White Balance	16			
4. CIRCUIT ADJUSTMENTS					
4-1.	B Board Adjustments	17			
4-2.	D Board Adjustments	20			

SAFETY-RELATED COMPONENT WARNING !!

COMPONENTS IDENTIFIED BY SHADING AND MARK  ON THE SCHEMATIC DIAGRAMS, EXPLODED VIEWS AND IN THE PARTS LIST ARE CRITICAL TO SAFE OPERATION. REPLACE THESE COMPONENTS WITH SONY PARTS WHOSE PART NUMBERS APPEAR AS SHOWN IN THIS MANUAL OR IN SUPPLEMENTS PUBLISHED BY SONY. CIRCUIT ADJUSTMENTS THAT ARE CRITICAL TO SAFE OPERATION ARE IDENTIFIED IN THIS MANUAL. FOLLOW THESE PROCEDURES WHENEVER CRITICAL COMPONENTS ARE REPLACED OR IMPROPER OPERATION IS SUSPECTED.

ATTENTION AUX COMPOSANTS RELATIFS À LA SÉCURITÉ!!

LES COMPOSANTS IDENTIFIÉS PAR UNE TRAME ET PAR UNE MARQUE  SUR LES SCHÉMAS DE PRINCIPE, LES VUES EXPLOSÉES ET LES LISTES DE PIÈCES SONT D'UNE IMPORTANCE CRITIQUE POUR LA SÉCURITÉ DU FONCTIONNEMENT. NE LES REMPLACER QUE PAR DES COMPOSANTS SONY DONT LE NUMÉRO DE PIÈCE EST INDIQUÉ DANS LE PRÉSENT MANUEL OU DANS DES SUPPLÉMENTS PUBLIÉS PAR SONY. LES RÉGLAGES DE CIRCUIT DONT L'IMPORTANCE EST CRITIQUE POUR LA SÉCURITÉ DU FONCTIONNEMENT SONT IDENTIFIÉS DANS LE PRÉSENT MANUEL. SUIVRE CES PROCÉDURES LORS DE CHAQUE REMPLACEMENT DE COMPOSANTS CRITIQUES, OU LORSQU'UN MAUVAIS FONCTIONNEMENT EST SUSPECTÉ.

SECTION 1 GENERAL

1-1. LOCATION AND FUNCTION OF CONTROLS

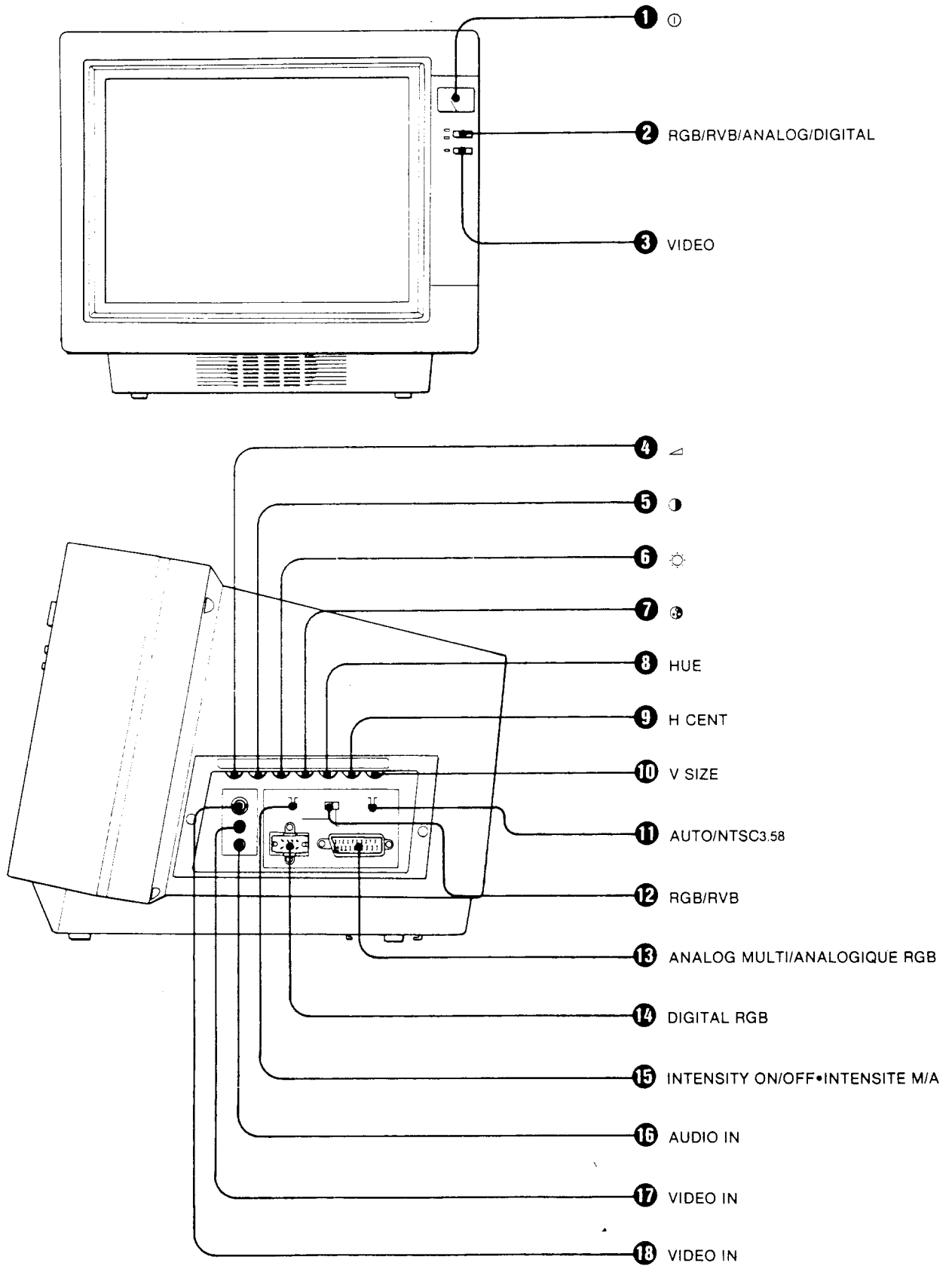

- 1 ① (power) switch**
Press to turn the unit on. Press again to turn off.
- 2 RGB/RVB button and ANALOG and DIGITAL indicators**
Press to view the signals from equipment connected to the ANALOG MULTI/ANALOGIQUE RGB input connector or the DIGITAL RGB input connector. The indicator of the RGB input select lights up.
- 3 VIDEO button and indicator**
Press to view the signals from the VIDEO IN jacks. The indicator lights up.
- 4 \sphericalangle (volume) control**
Turning clockwise increases the volume of the equipment connected or turning anticlockwise decreases the volume.
- 5 ① (picture) control**
Turning clockwise increases contrast with vivid colour and turning anticlockwise decreases contrast with soft colour.
- 6 \odot (brightness) control**
Turn clockwise for more brightness and turn anticlockwise for less brightness. Optimum level will be obtained with this control at the centre detent position.
- 7 ③ (colour) control**
Turn clockwise for more colour intensity or turn anticlockwise for less colour intensity.
- 8 HUE control**
Turning clockwise makes skin tones greenish and turning anticlockwise makes them purplish.
- 9 H CENT (horizontal centering) control**
Usually set this control at the center detent position. When equipment is connected to the unit at the ANALOG MULTI/ANALOGIQUE, DIGITAL RGB input connectors and VIDEO (either phono or BNC type) inputs, the display may be shifted off center to the left or right of the screen. In this case, center the display by turning this control clockwise or anticlockwise. The display moves in the opposite direction the control is turned.
- 10 V (vertical) SIZE control**
Usually, turn this control fully clockwise. To reduce the picture size vertically, turn it anticlockwise. Pictures of the equipment connected to the ANALOG, DIGITAL RGB connectors, and VIDEO (phono and BNC type) inputs can be adjusted. When turning the control anticlockwise, RGB rasters sometimes appear at the top of the screen, depending on the computer used.
- 11 AUTO/NTSC3.58 system select switch**
Usually set this switch to AUTO. When receiving NTSC3.58 system signals, set this switch to NTSC3.58 for better reception.
- 12 RGB/RVB input select switch**
Set this switch at DIGITAL or ANALOG MULTI/ANALOGIQUE to view RGB input signals.
- 13 ANALOG MULTI/ANALOGIQUE RGB input connector (21 pin)**
Connect to the analog RGB multi output connector of a video cassette recorder, video disc player, microcomputer, monitor, etc., which has an analog RGB output connector.
- 14 DIGITAL RGB input connector (8 pin)**
Connect to the digital RGB output connector of a microcomputer, etc., which has a digital RGB output connector.
- 15 INTENSITY ON/OFF•INTENSITE M/A input select switch**
Usually set this switch at OFF. When a microcomputer or a TV tuner is connected to the DIGITAL RGB connector and its pin number 1 is used for the intensity input, set this switch to ON.
- 16 AUDIO IN (input) jack (phono type)**
Connect to the audio output of a video cassette recorder, video disc player, microcomputer, monitor, TV tuner etc.
- 17 VIDEO IN (input) jack (phono type)**
Connect to the video output of a video cassette recorder, video disc player, microcomputer, monitor, etc., which has phono type video output jack.
- 18 VIDEO IN (input) jack (BNC type)**
Connect to the video output of a video cassette recorder, video disc player, microcomputer, monitor, etc., which has BNC type video output jack.

Caution:

Use either the phono type or BNC type VIDEO input connector, but not both simultaneously.

FEET

To set the screen vertically

Attach the supplied feet to the bottom of the unit as illustrated.

Attach the foot indicated "R" to the right and the one indicated "L" to the left. Fully insert the projections of the foot into the hooks.

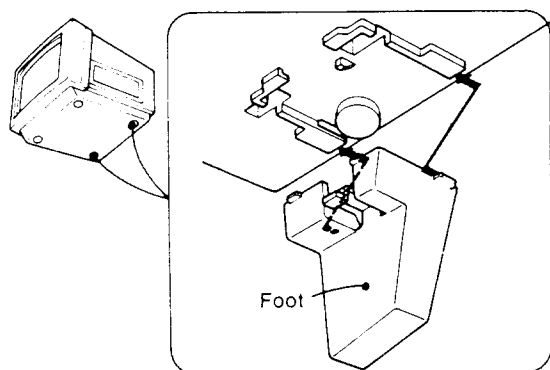

To remove

While pressing down the tab, pull out the foot.

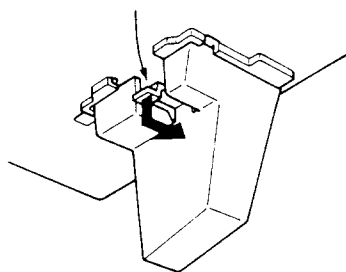

1-2. APPLICATIONS WITH OTHER OPTIONAL EQUIPMENT

This unit is equipped with various multiconnectors for your desired equipment to be connected.

VTR CONNECTION

Be sure to use a connecting cable that matches the connector of your VTR (or portable VTR). Read the instruction manual of the VTR if you are not sure what type of connectors your VTR has.

Keep the VTR away from the unit, if the display or sound is affected.

NOTES ON CONNECTION

- Before connecting, make sure that the power to each piece of equipment is turned off.
- The plugs should be fully inserted into the jacks or connectors. A loose connection may cause hum and noise.
- Match the colour when connecting the plugs to jacks.

VTRs that are capable of receiving TV broadcasts

With this you will be able to—

- View the playback of tapes
- Record TV programmes and monitoring recording
- View a TV programme

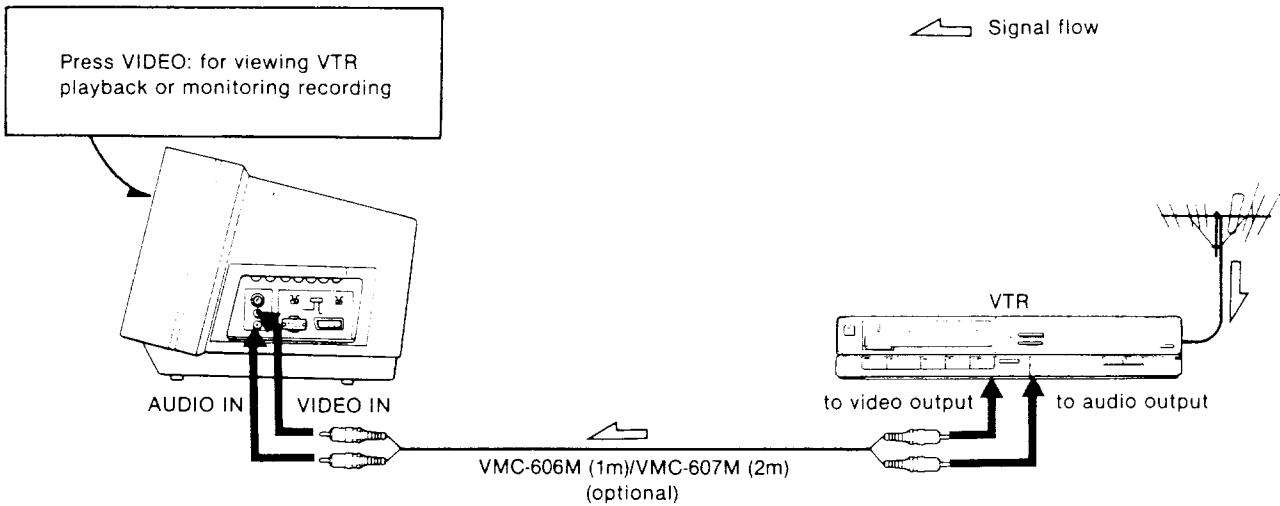

If the VTR is equipped with a mini-type audio output jack, use the optional PC-21M plug adaptor.

Portable VTRs that are not equipped with or connected to a TV tuner—for playing back recorded tapes

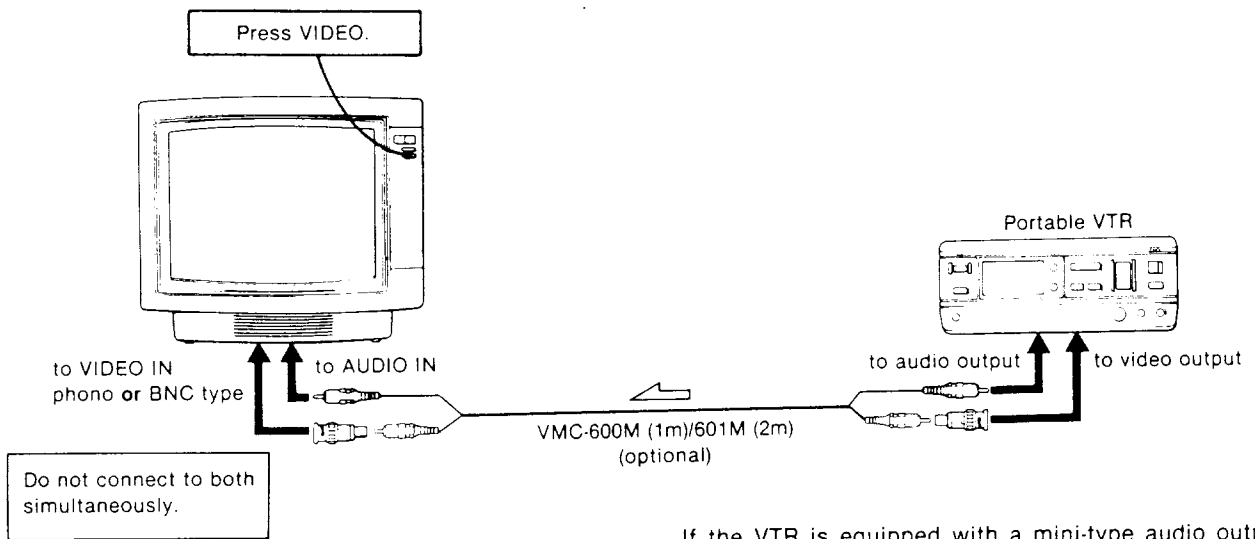

If the VTR is equipped with a mini-type audio output jack, use the plug adaptor supplied with the VMC-612MS video cable.

Caution

When you connect a VTR to the phono connector and another to the BNC connector at the same time, the display may be affected. Use only one of these connectors and the ANALOG MULTI/ANALOGIQUE connector when you need to connect two VTRs.

Use an appropriate connecting cable to connect the VTR to the ANALOG MULTI/ANALOGIQUE RGB (21 pin) input connector.

In this case press the RGB/RVB button, and check that the RGB/RVB input select switch is switched to ANALOG MULTI/ANALOGIQUE so that the picture is displayed.

MICROCOMPUTER CONNECTION

Microcomputer with analog RGB output

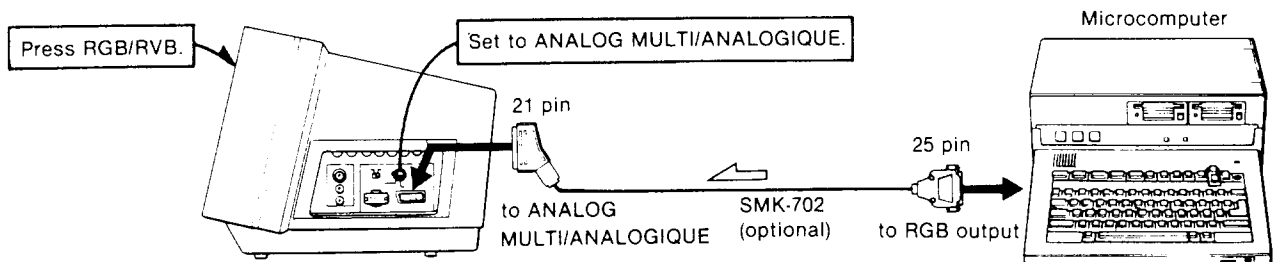

Microcomputer with digital RGB output

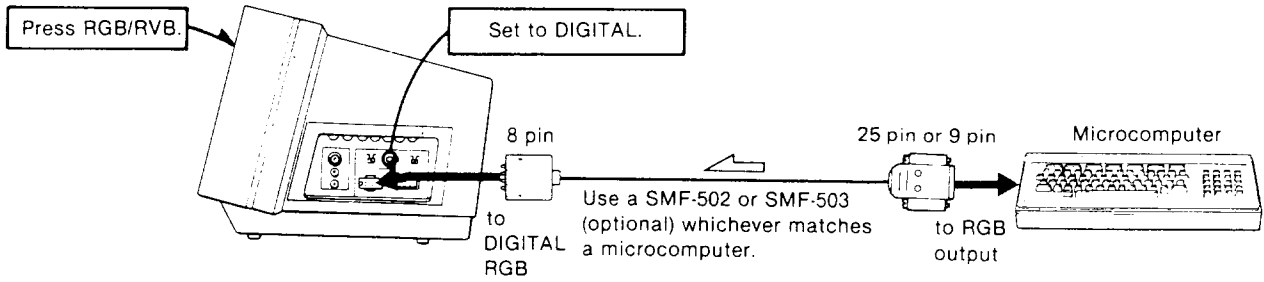

If the microcomputer is equipped with an 18-pin RGB output, connect as follows.

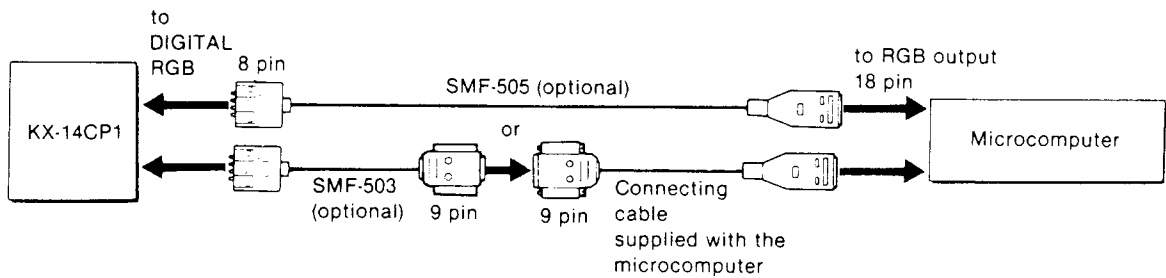

If the microcomputer is equipped with an audio output jack, the sound from the microcomputer can be heard by connecting the audio output jack to the AUDIO IN jack of the unit.

Microcomputer with video and audio outputs

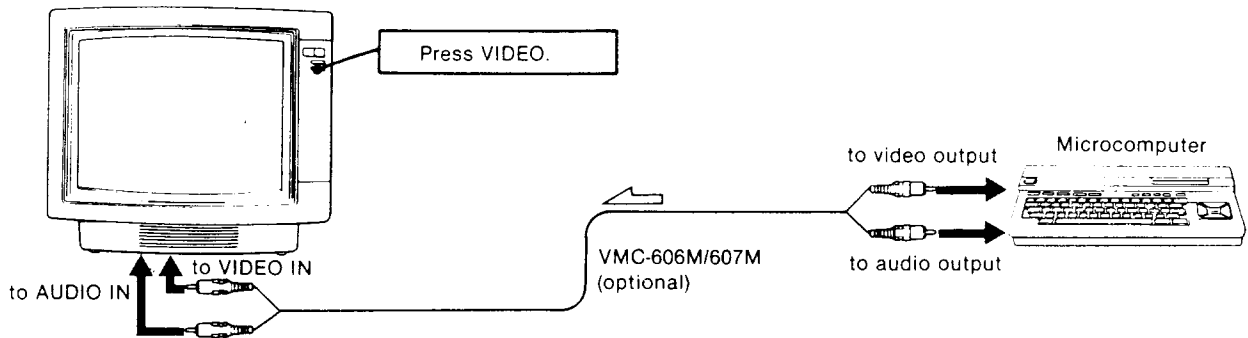

If your microcomputer is equipped with a mini-type audio output jack, use the optional plug adaptor PC-21M.

For Service Manuals
MAURITRON SERVICES
 8 Cherry Tree Road, Chinnor
 Oxfordshire, OX9 4QY.
 Tel (01844) 351894
 Fax (01844) 352554
 email:- mauritron@dial.pipex.com

1-3. FEATURES

- **New black-tinted picture tube** with more finely pitched aperture grille (0.37mm) for higher resolution, higher contrast picture
- **New Sharp Focus Electron Gun** for clear and crisp images with remarkably improved sharpness all the way to the edges and corners of the screen
- **Digital RGB input (8-pin) and analog RGB multi-connector (21-pin)** for connecting a microcomputer or other equipment
- **Selectable video inputs**, BNC type or phono type
- **Intensity input select switch** to receive signals fed through pin number 1 of the DIGITAL RGB input
- **Wide range video frequency circuitry** for 2000 characters and for beautiful color graphics display from a microcomputer
- Correctable horizontal position and vertical size for RGB and VIDEO input pictures
- PAL/SECAM/NTSC^{4.43} systems acceptable automatically (switchable to NTSC^{3.58})
- Compact, easy-to-view slant design

SECTION 2 DISASSEMBLY

2-1. BACK COVER REMOVAL

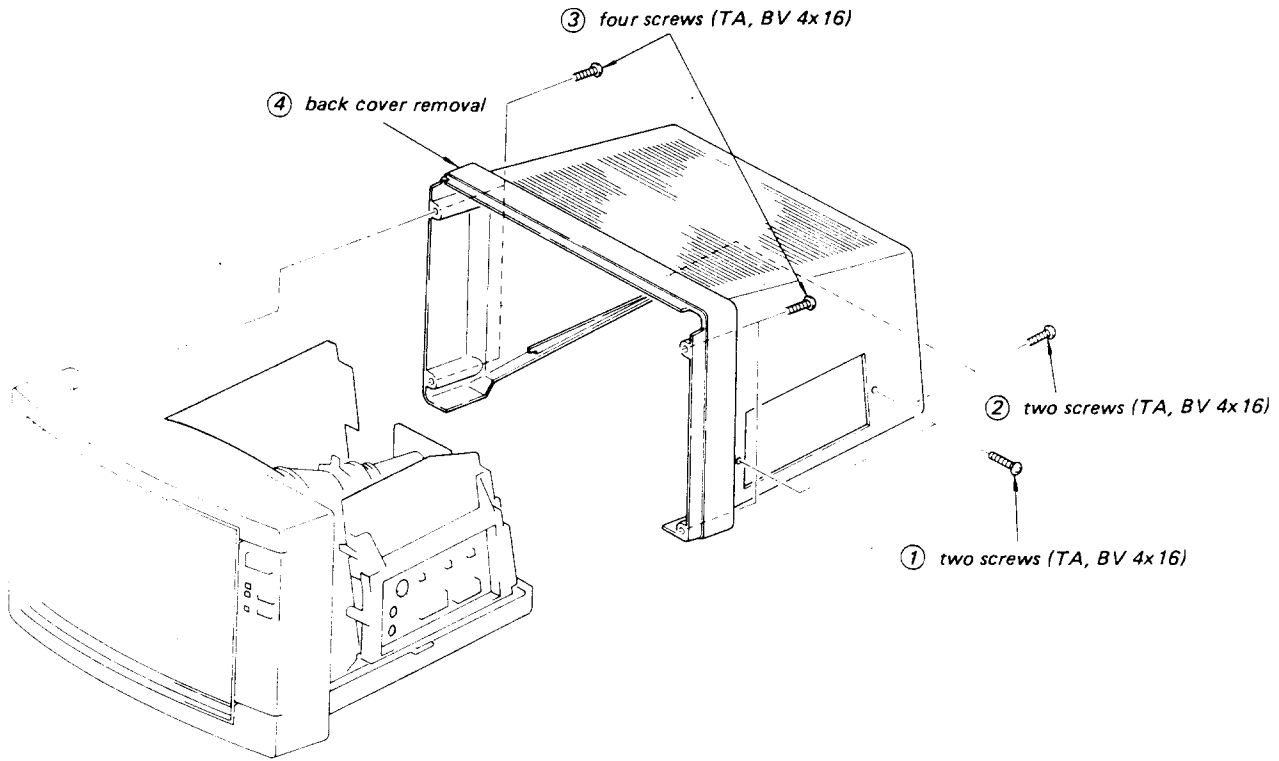

2-2. F BOARD REMOVAL

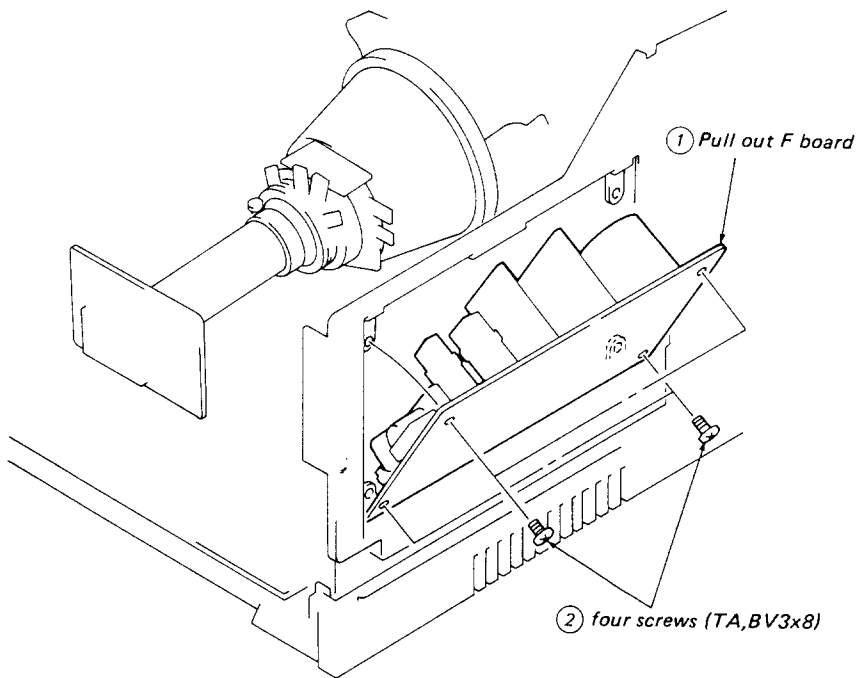

2-3. CHECKING FOR D BOARD

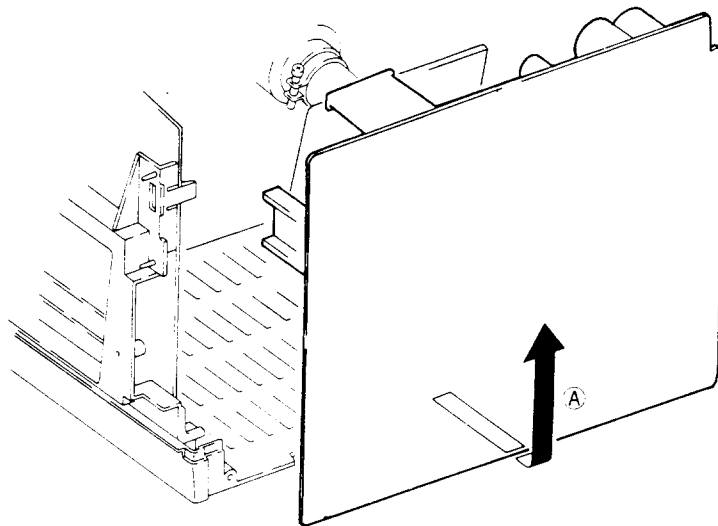

2-4. CHECKING FOR B BOARD

① one screw (TA, BV 4x16)

② Lay the B board to the direction shown by the arrows A and B

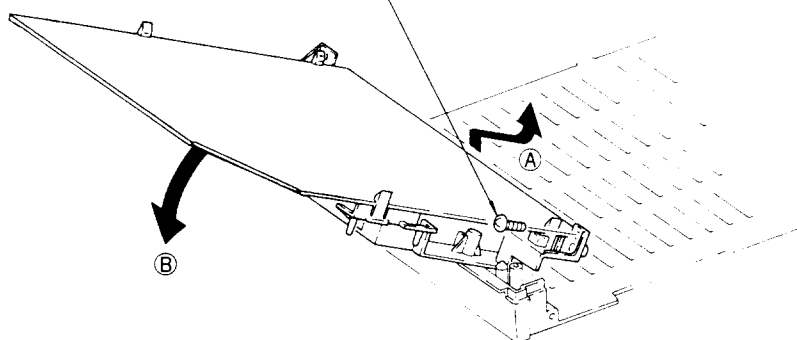

2-5. REMOVAL OF ANODE CAP

● Removing Procedures

③ When one side of the rubber cap is separated from the anode button, the anode cap can be removed by turning up the rubber cap and pulling up it in the direction of the arrow C.

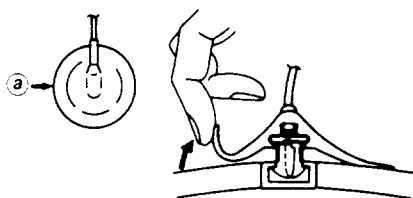

① Turn up one side of the rubber cap in the direction indicated by the arrow (a).

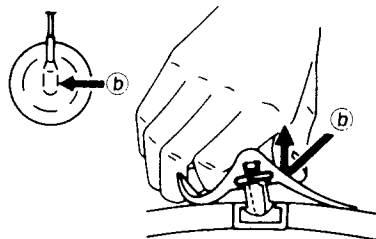

② Using a thumb, pull up the rubber cap firmly in the direction indicated by the arrow (b).

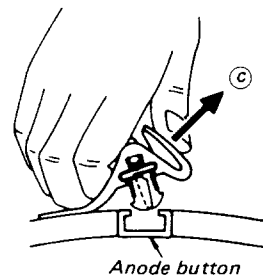

2-6. PICTURE TUBE REMOVAL

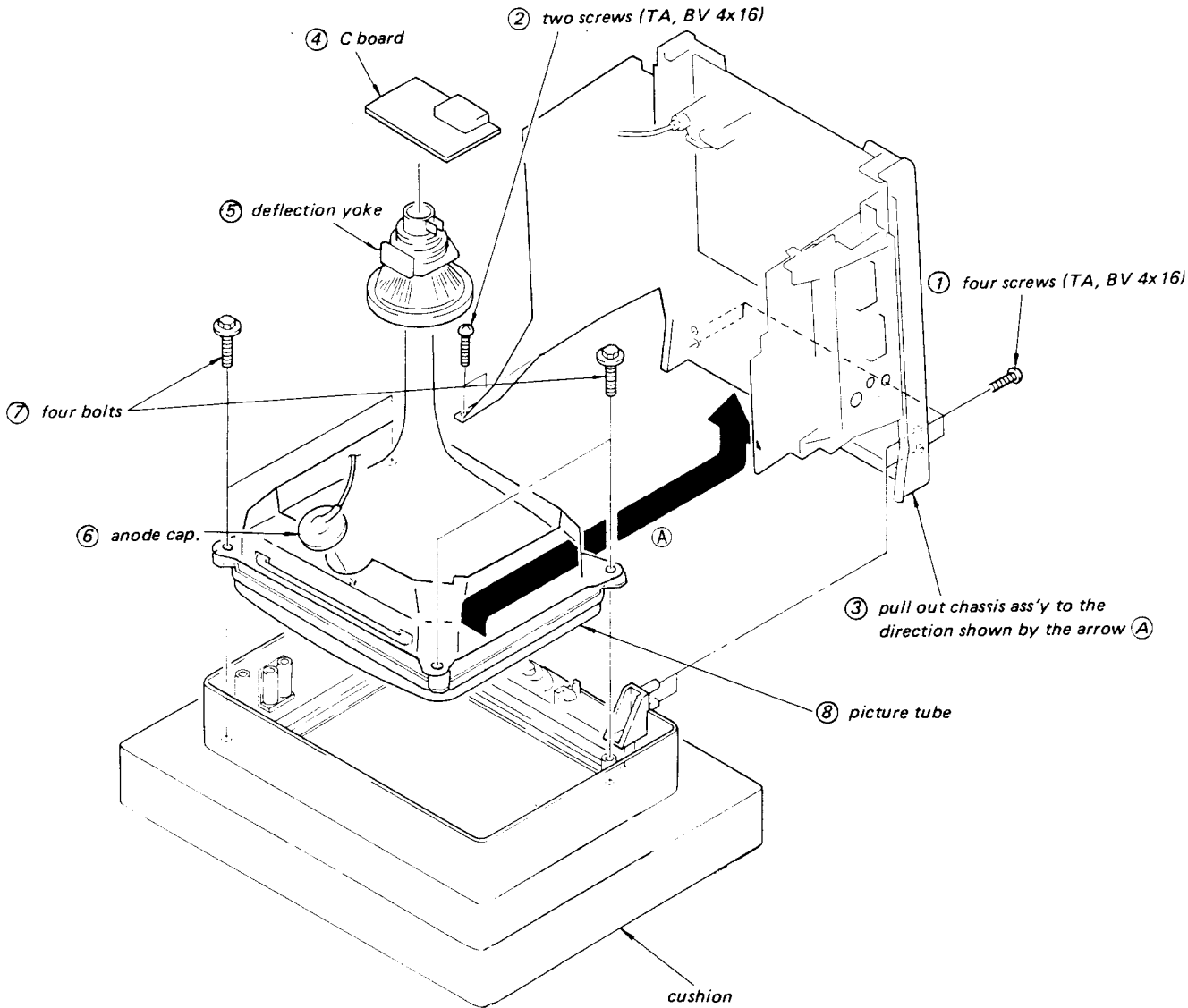

7e
7g
7e

SECTION 3 SET-UP ADJUSTMENTS

The following adjustments should be made when a complete realignment is required or a new picture tube is installed.

These adjustments should be performed with rated power supply voltage unless otherwise noted.

Controls and switch should be set as follows unless otherwise noted:

- picture control maximum
(fully clockwise)
- ☀ brightness control maximum
(fully clockwise)

Perform the adjustments in order as follows:

- 3-1. Beam Landing
- 3-2. Convergence
- 3-3. Focus(RV701)
- 3-4. White Balance

Note: Test Equipment Required.

- 1. Color-bar/Pattern Generator
- 2. Degausser

3-1. BEAM LANDING

1. Input a raster signal with the pattern generator.

PICTURE	}	normal
BRT		
2. Turn the raster signal of the pattern generator to red.
3. Move the deflection yoke backward, and adjust with the purity control so that red is in the center and blue and green are at the sides, evenly.
4. Move the deflection yoke forward, and adjust so that the entire screen becomes red.
5. Switch over the raster signal to blue and green and confirm the condition.
6. When landing at the corners is not right, adjust by using the magnet.
7. When the position of the deflection yoke is determined, tighten it with a deflection yoke mounting screw.

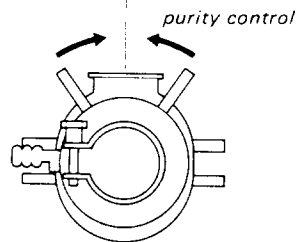

Fig. 3-1.

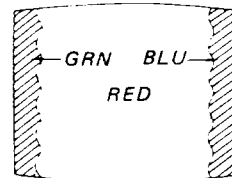
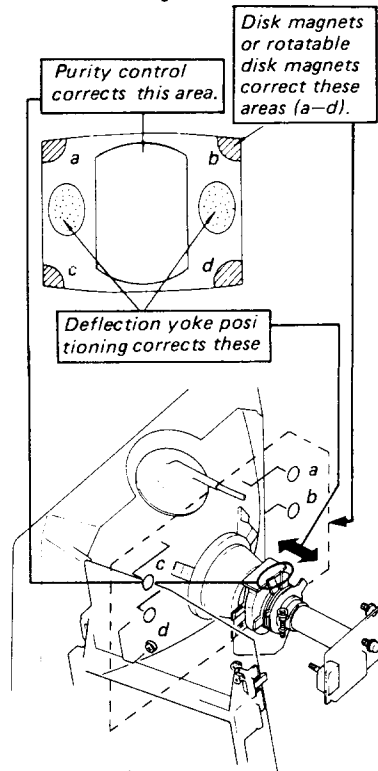
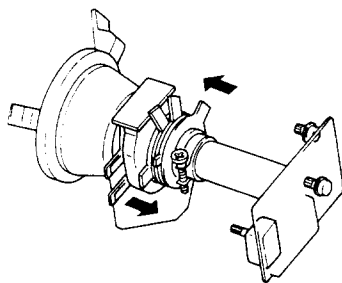

Fig. 3-2.



3.2. CONVERGENCE

Preparation:

- Before starting, perform FOCUS, H.SIZE, V.SIZE and V.LIN adjustments.
- Turn BRIGHTNESS control fully counterclockwise and PICTURE VR to mechanical centre.
- Feed in the dot pattern.

(1) Horizontal and Vertical Static Convergence

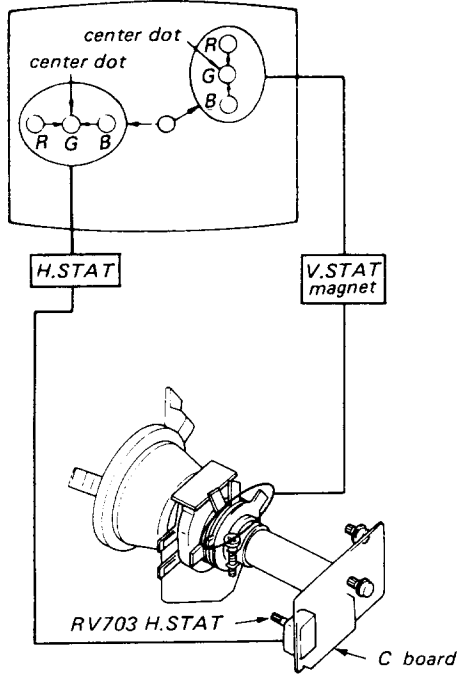

1. Adjust H.STAT VR to coincide red, green and blue dots on the centre of screen (Horizontal movement)
 2. Adjust V.STAT magnet to coincide red, green and blue dots on the centre of screen (Vertical movement)
 3. If the red, green and blue dots do not coincide on the centre of screen with H.STAT VR, perform horizontal convergence adjustment using H.STAT VR and V.STAT magnet as shown below. (In this case, H.STAT VR and V.STAT magnet effect each other.)
- Tilt the V.STAT magnet and adjust static convergence to open or close the V.STAT magnet.

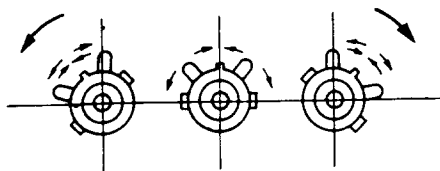

4. When the V.STAT magnet is moved in the direction of arrow (a) and (b), red, green and blue dots move as shown below.

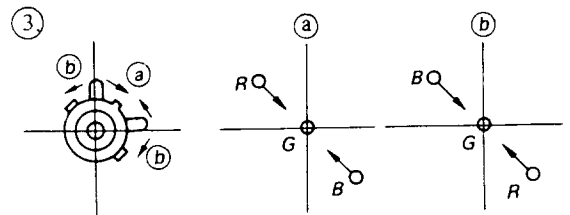
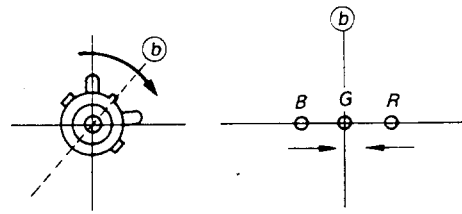
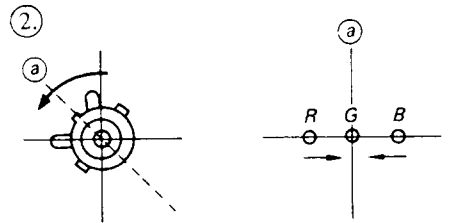
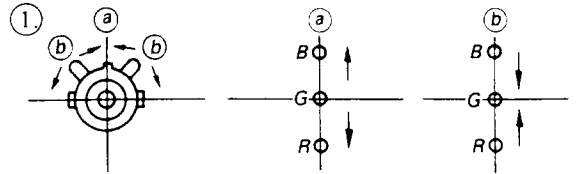

If blue dot does not coincide with red and green dots, perform following steps.

Move BMC magnet (a) to correct insufficient H. static convergence.

Rotate BMC magnet (b) to correct insufficient V. static convergence.

In either case, repeat Beam Landing Adjustment.

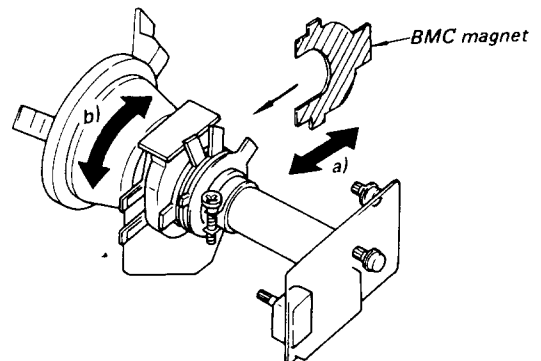

(2) Dynamic Convergence Adjustment

Preparation:

- Before starting, perform Horizontal and Vertical Static Convergence Adjustment.

1. Loosen deflection yoke screw.
2. Remove deflection yoke spacers.
3. Move the deflection yoke for best convergence as shown below.
4. Tighten the deflection yoke screw.
5. Install the deflection yoke spacers.

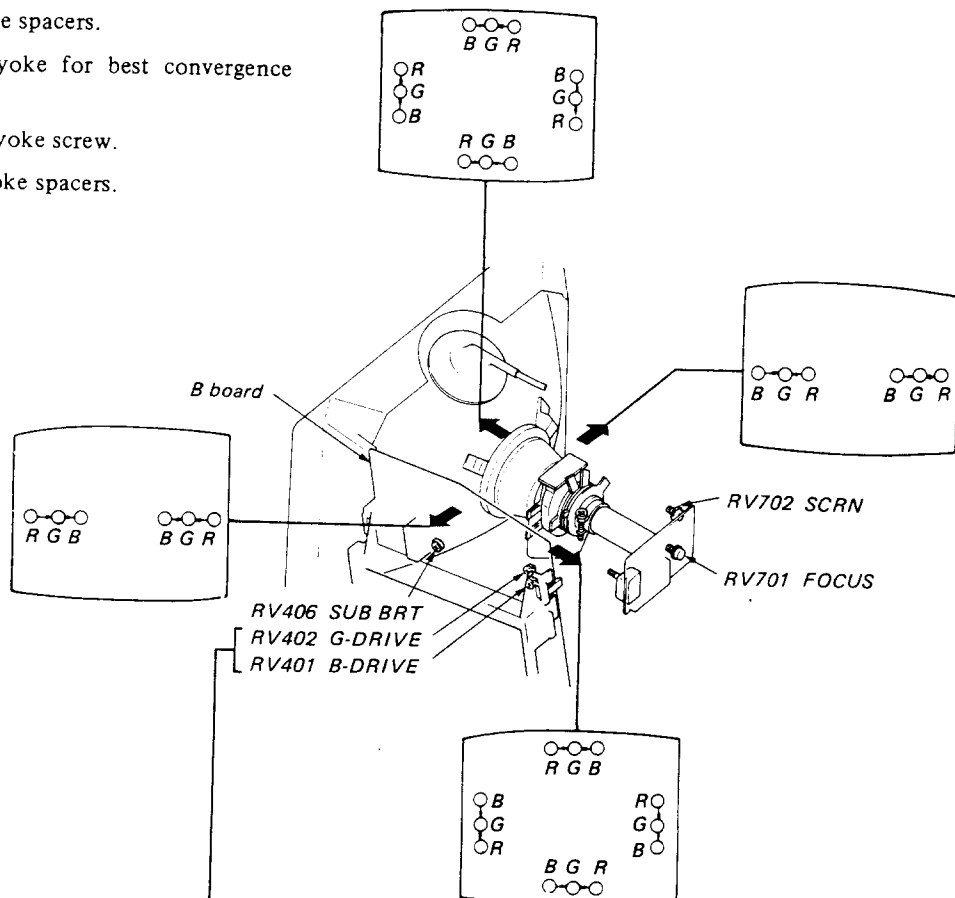

3-3. FOCUS(RV701)

Adjust Focus VR(RV701) for a best Picture.

3-4. WHITE BALANCE

1. Receive a monoscope signal.
 PICTURE VR 50%
 BRT VR center click
 G (RV402) DRIVE VR } ... 50%
 B (RV401) DRIVE VR }
 2. Adjust white balance with G (RV402) and B (RV401), respectively.

SECTION 4 CIRCUIT ADJUSTMENTS

4-1. B BOARD ADJUSTMENTS

SECAM ADJUSTMENT

- (1) BELL Filter adjustment.
 1. Input a SECAM color bar.
 2. Observe (E) Q302 waveform and adjust T301 (Bell Filter) so that the waveform level becomes uniform.

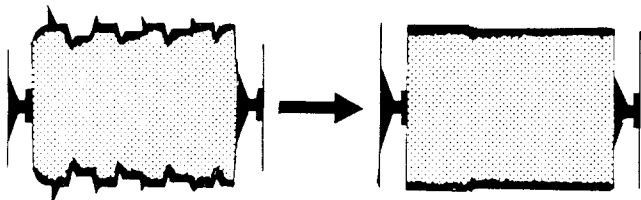

- (2) ID Adjustment (Intermodulation distortion)
 1. Input a SECAM color bar.
 2. Observe pin (22) IC301 waveform and adjust L305 (SECAM ID) so that the waveform level becomes flat.

REF OSC

1. Input color bar.
2. Set into PAL mode.
 - Connect pin (28) of IC301 and +12V by inserting a resistor of 3.3kΩ between them.
3. Ground pin (17) of IC301 and turn color killer OFF.
4. Adjust CT301 so that the movement of picture on the CRT becomes the slowest.
5. Release PAL mode. (Recover Step 2. to the original.)
6. Input NTSC 3.58 color bar.
7. Turn S301 switch ON and set into NTSC 3.58 mode.
8. Adjust CT302 so that the movement of picture on the CRT becomes the slowest.
9. Recover Step 3. to the original.

1H DELAY LINE

1. Input a PAL color bar.
2. Observe the pin (3) IC301 waveform on the oscilloscope, and adjust so that the chroma component becomes minimum with L303.
3. Confirm that there is no color on the first anti-PAL signal frames at the right and left of the picture if sides while tracking with RV301 and L303.

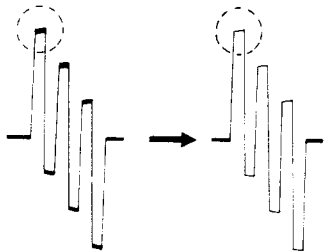

oscilloscope

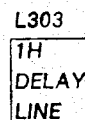
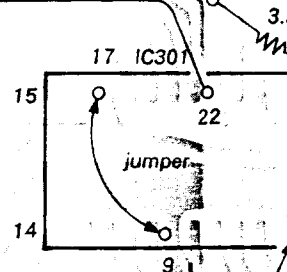
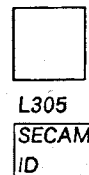
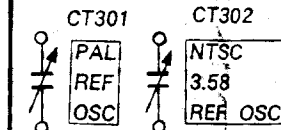
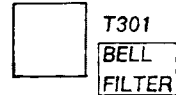
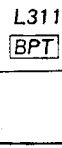
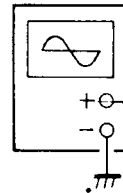

oscilloscope

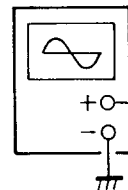

28

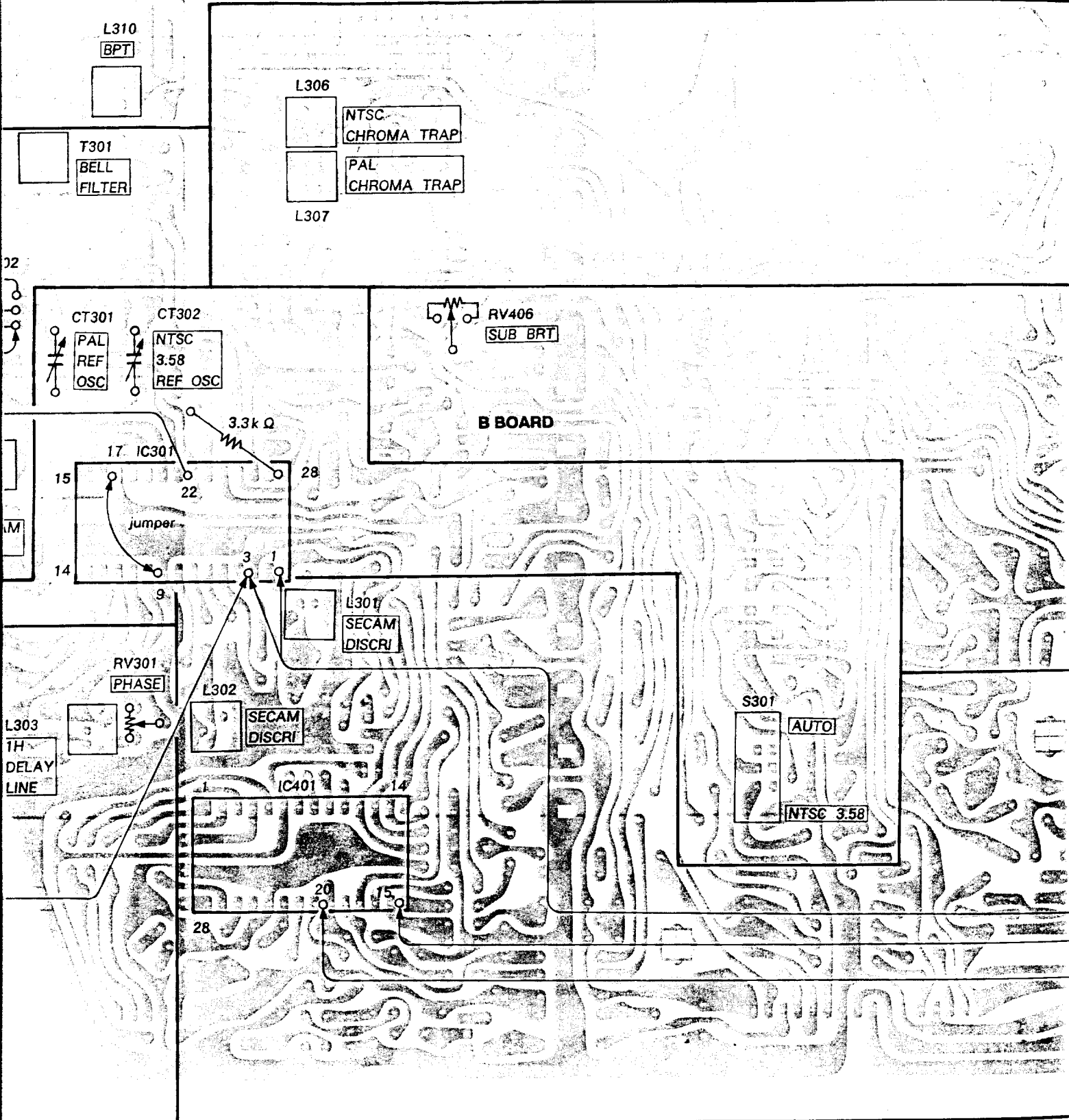

P
P

RV406
SUB BRT

B BOARD

S301
AUTO
NTSC 3.58

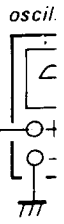
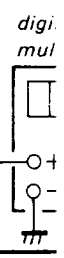
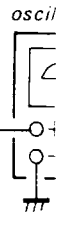

BPT

1. Input color bar.
2. Adjust with BPT (L310, L311) to obtain a suitable picture.

CHROMA TRAP

1. Input a PAL color bar.
2. Observe pin ⑮ IC401 waveform on the oscilloscope and adjust L307 for minimum chroma component.
3. Input a NTSC 3.58 color bar.
4. Observe pin ⑮ IC401 waveform on the oscilloscope and adjust L306 for minimum chroma component.

oscilloscope

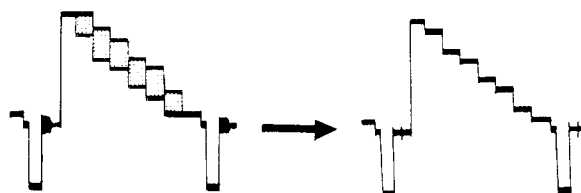
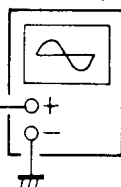

digital multimeter

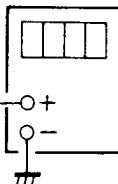

SUB BRIGHT

1. Input NTSC 3.58 color bar. BRT... mechanical center.
2. Connect a digital voltmeter between pin ⑳ IC401 and ground, and adjust RV406 so that the digital voltmeter reading becomes 1.8VDC.

SECAM DISCRI

1. Input a SECAM color bar.
2. Observe pin ①, ③ IC301 waveform on the oscilloscope, and adjust L301, L302 so that the waveform level becomes minimum.

oscilloscope

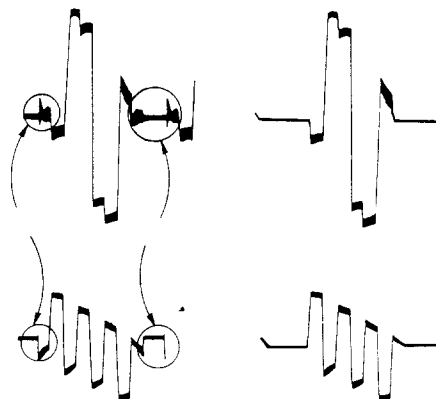
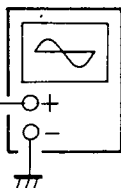

4-2. D BOARD ADJUSTMENTS

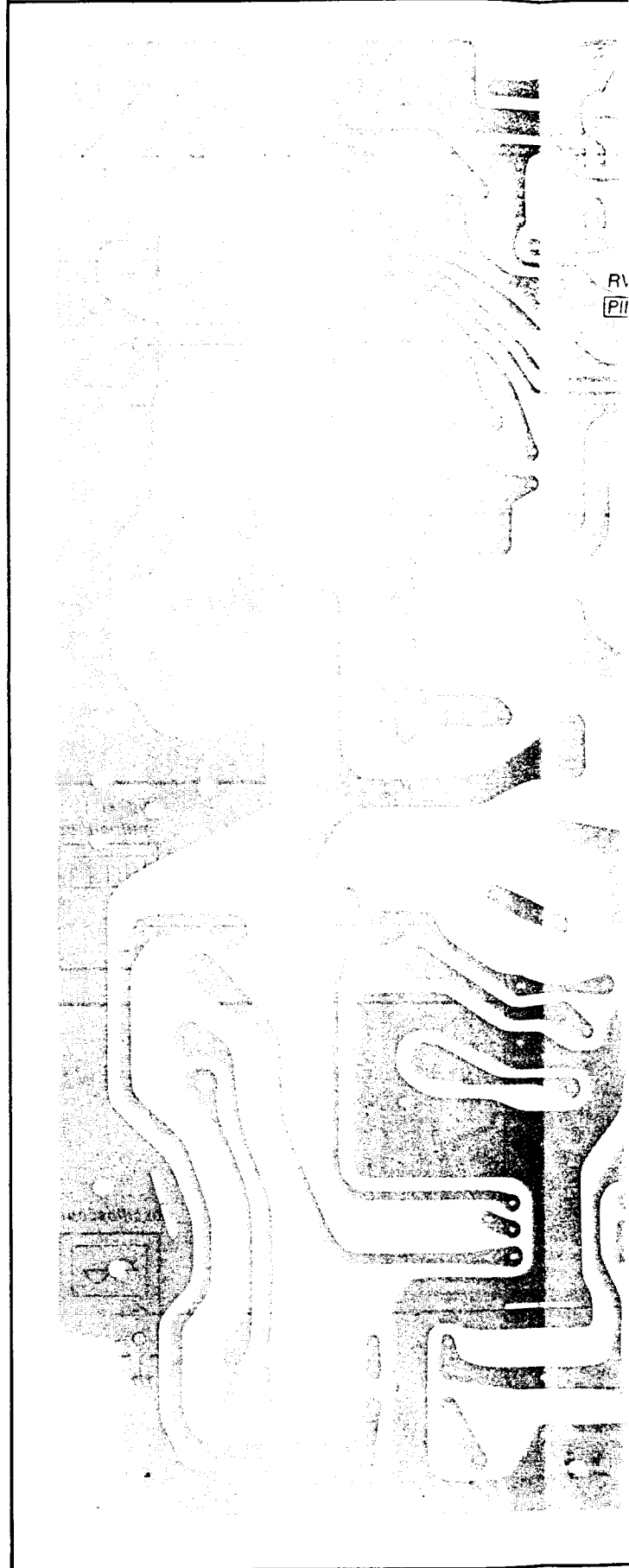

RV505
V. LIN

RV506
V. SIZE

RV803
PIN - AMP

RV801
PIN - PHASE



RV805
H. SIZE

RV551
V. CENT

D BOARD

RV506
V. SIZE



V.SIZE, V.LIN

1. Input a cross hatch pattern.

PICTURE	}	mechanical center
BRIGHT		
2. Adjust V.SIZE with RV506.
3. Adjust V.LIN with RV505.

ASE

IC501

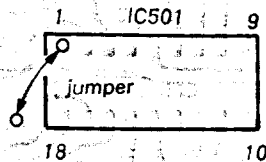

1 9
18 10
jumper

RV551
V. CENT



RV504
H. FREQ



H.FREQ

1. Input a PAL color bar.

PICTURE	}	mechanical center
BRIGHT		
2. Short circuit between ground and
with jumper.
3. Adjust RV504 (H.FREQ) for sta

V.CENT, H.CENT

1. Input a cross hatch pattern.

PICTURE	}	mechanical center
BRIGHT		
2. Adjust with V.CENT (RV551)
centered.

H.SIZE, PIN AMP, PIN PHASE

1. Input a cross hatch pattern.

PICTURE	}	mechanical center
BRIGHT		
2. Adjust H.SIZE with RV805.
3. Adjust with PIN AMP (RV803
(RV801) to obtain a suitable pi

V.SIZE, V.LIN

1. Input a cross hatch pattern.

PICTURE	}	mechanical center
BRIGHT		
2. Adjust V.SIZE with RV506.
3. Adjust V.LIN with RV505.

H.FREQ

1. Input a PAL color bar.

PICTURE	}	mechanical center
BRIGHT		
2. Short circuit between ground and pin ① of IC501 with jumper.
3. Adjust RV504 (H.FREQ) for stable picture.

V.CENT, H.CENT

1. Input a cross hatch pattern.

PICTURE	}	mechanical center
BRIGHT		
2. Adjust with V.CENT (RV551) so that picture is centered.

H.SIZE, PIN AMP, PIN PHASE

1. Input a cross hatch pattern.

PICTURE	}	mechanical center
BRIGHT		
2. Adjust H.SIZE with RV805.
3. Adjust with PIN AMP (RV803) and PIN PHASE (RV801) to obtain a suitable picture.

For Service Manuals
MAURITRON SERVICES
 8 Cherry Tree Road, Chinnor
 Oxfordshire, OX9 4QY.
 Tel (01844) 351894
 Fax (01844) 352554
 email:- mauritron@dial.pipex.com

SECTION 5 DIAGRAMS

5-1. CIRCUIT BOARDS LOCATION

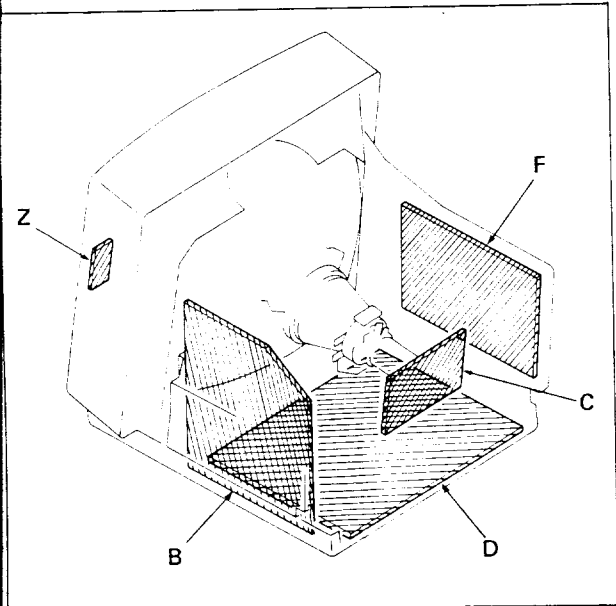

5-2. BLOCK DIAGRAM

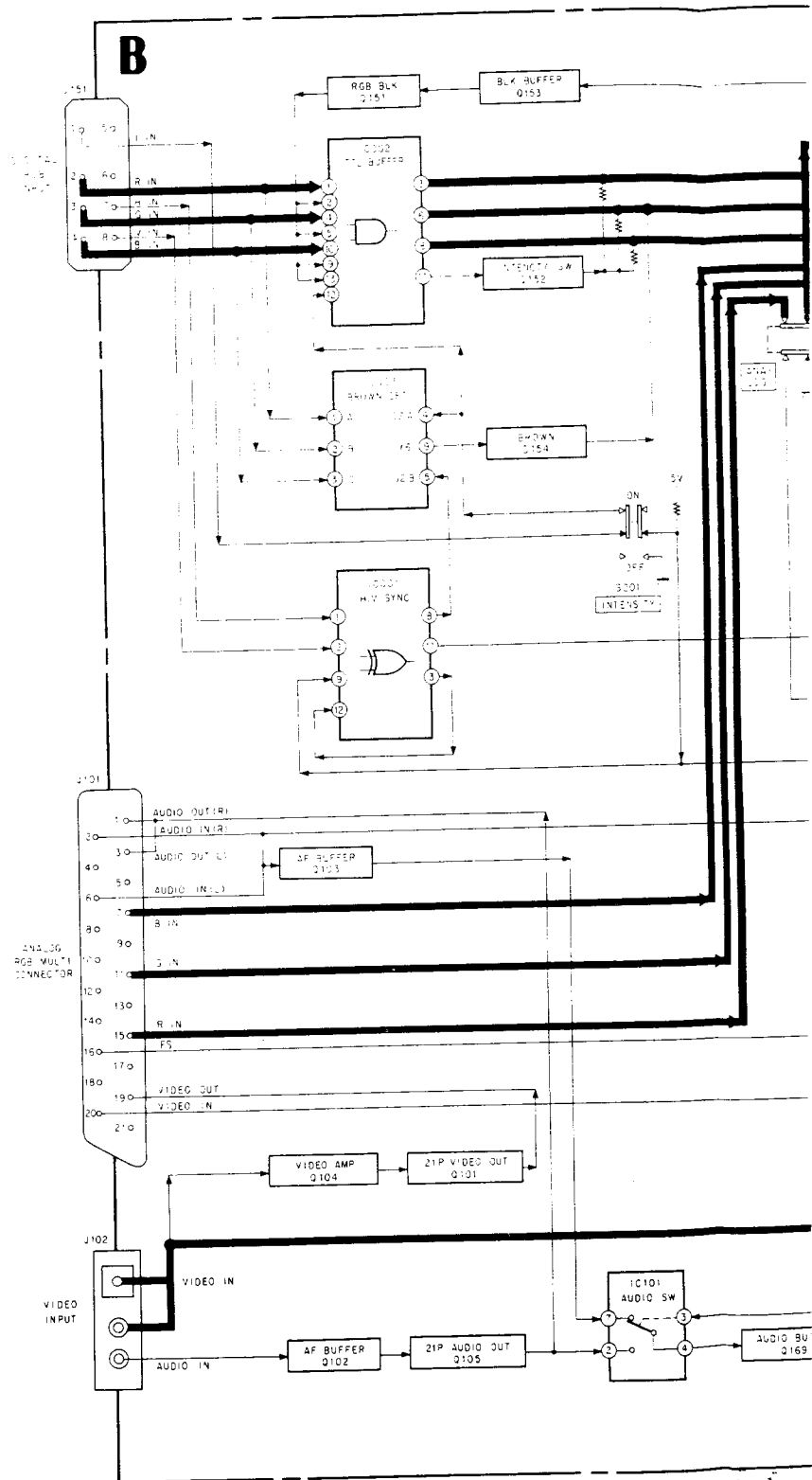

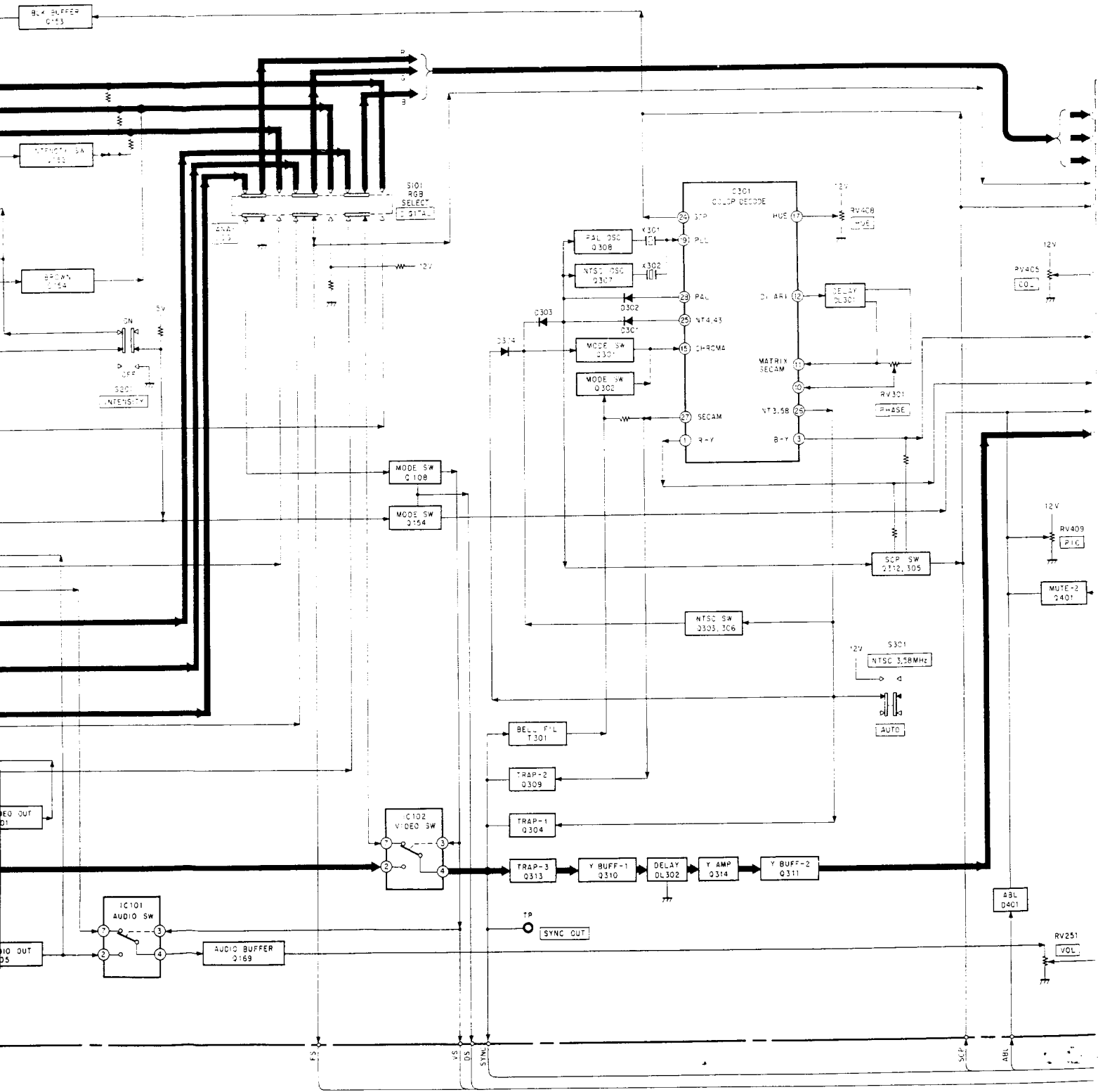

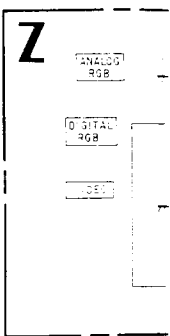
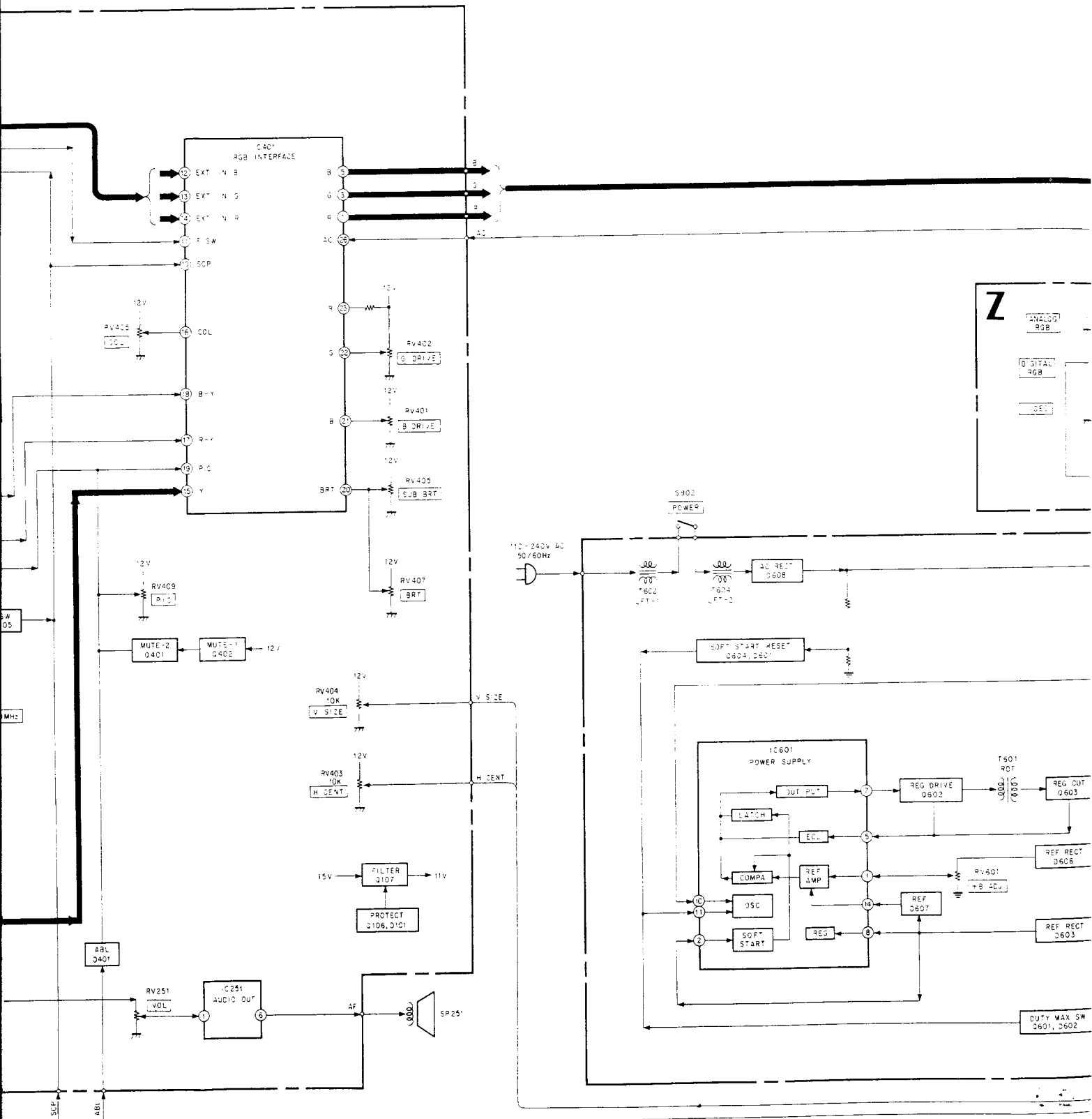

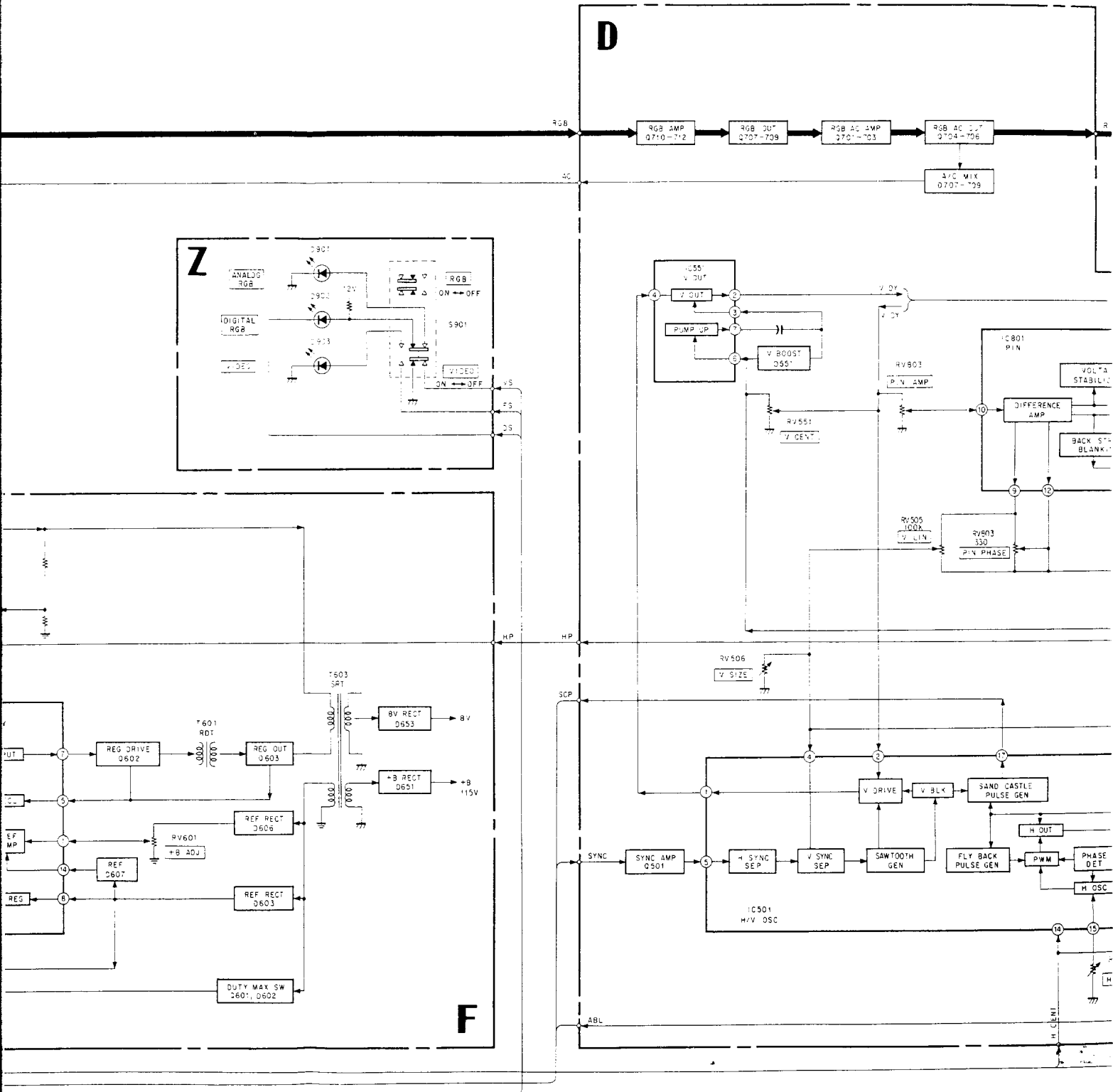

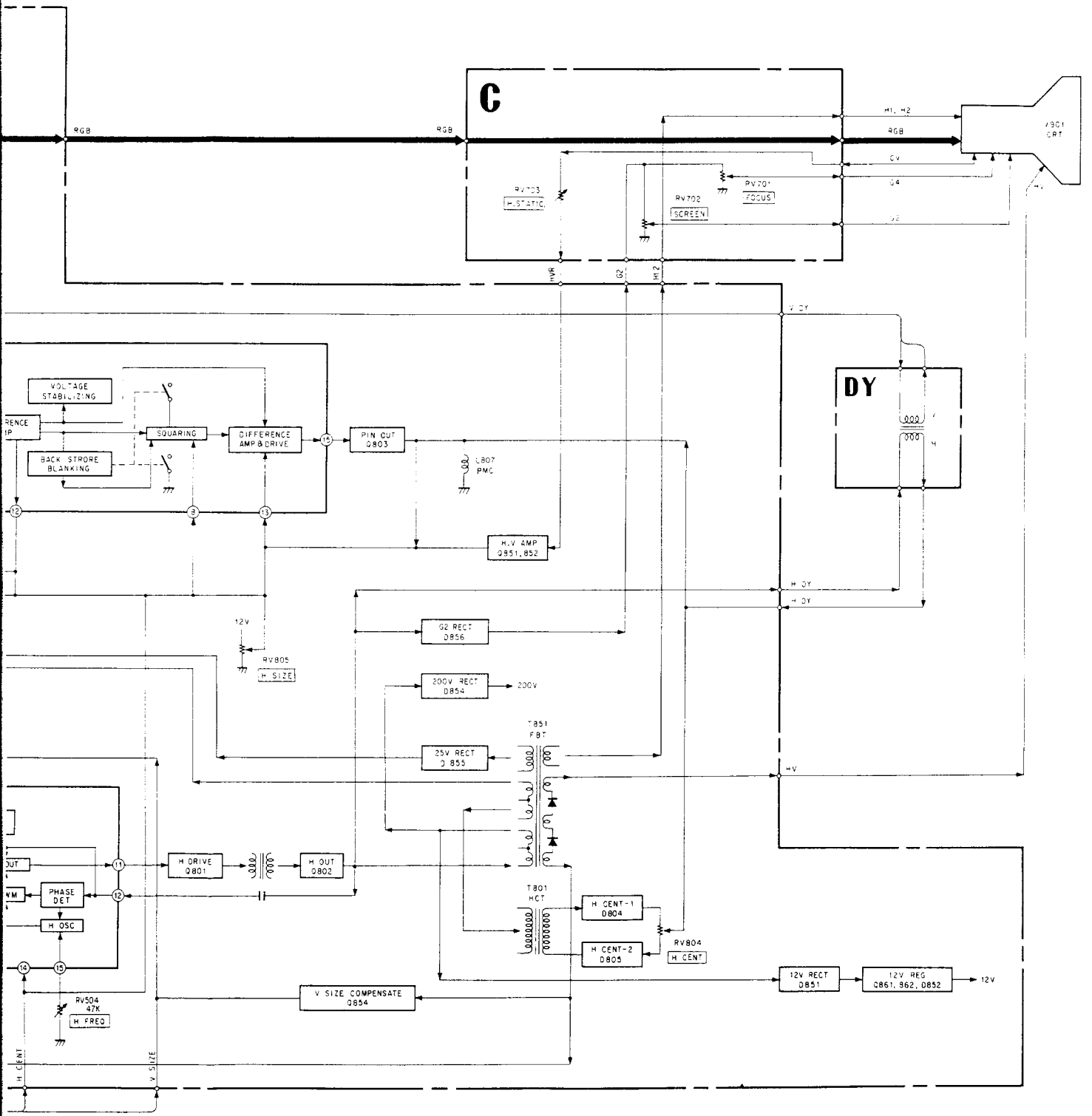

5-3. SEMICONDUCTORS

CX20061



μ PC1378H-L

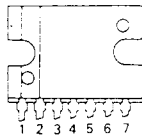

2SC2958
2SC2959
2SD774



ERC26-15S



SY432D



SN74LS09N
SN74LS86N
 μ PC1394C

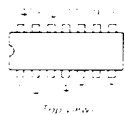

2SA1015
2SA1015-GR
2SA1091
2SA733



2SC3460
2SD1397
2SD1497

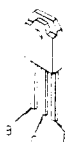

ERD28-06S
ERD28-08
HZ12B3
HZ5.1EB1
HZ5B3
HZ9A2
RD13EN3
RD15EL2
RD5.1EB1
RD5.1EN1
RD5.6EL2
RD6.2EB1
RD8.2EN2

V06C
V19E

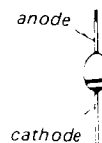

SN74LS138N
TDA1082

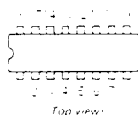

2SA1026



2SD1134

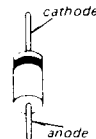

TDA2579

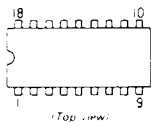

2SA1048
2SA1115
2SC2458
2SC2603



10E-2
EM-1Z
ERB12-02RK
ES1F
GP08D
RGP10G



GH3F
U05G

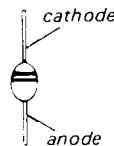

TDA3505
TDA4555

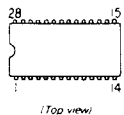

2SA1175
2SC2785



1SS119
1SS133
1SS148



RB406NH



μ PC1241H

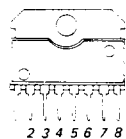

2SC2456
2SC2611
2SC2688

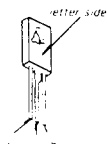

ERC24-06S
ERC25-06S
RH-1
RH-1A
RH-1Z
SIB01-02



S3WB60S
S3WB60Z
S3WB60ZS

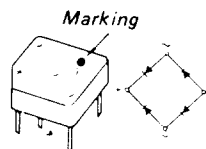

5-4. SCHEMATIC DIAGRAMS

1 2

ERC26-15S



SY432D

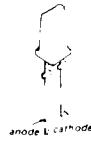

ERD28-06S
ERD28-08
HZ12B3
HZ5.1EB1
HZ5B3
HZ9A2
RD13EN3
RD15EL2
RD5.1EB1
RD5.1EN1
RD5.6EL2
RD6.2EB1
RD8.2EN2

V06C
V19E

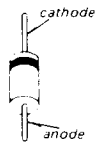
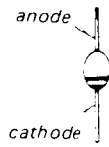

GH3F
U05G

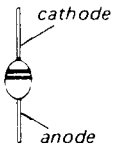

RB406NH

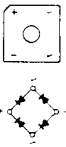

S3WB60S
S3WB60Z
S3WB60ZS

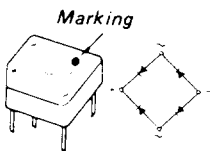

A

B

C

D

E

F

G

H

I

DIGITAL
RGB
INPUT

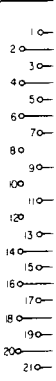
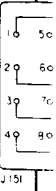

ANALOG
MULTI
CONNECTOR

VIDEO
INPUT

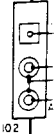

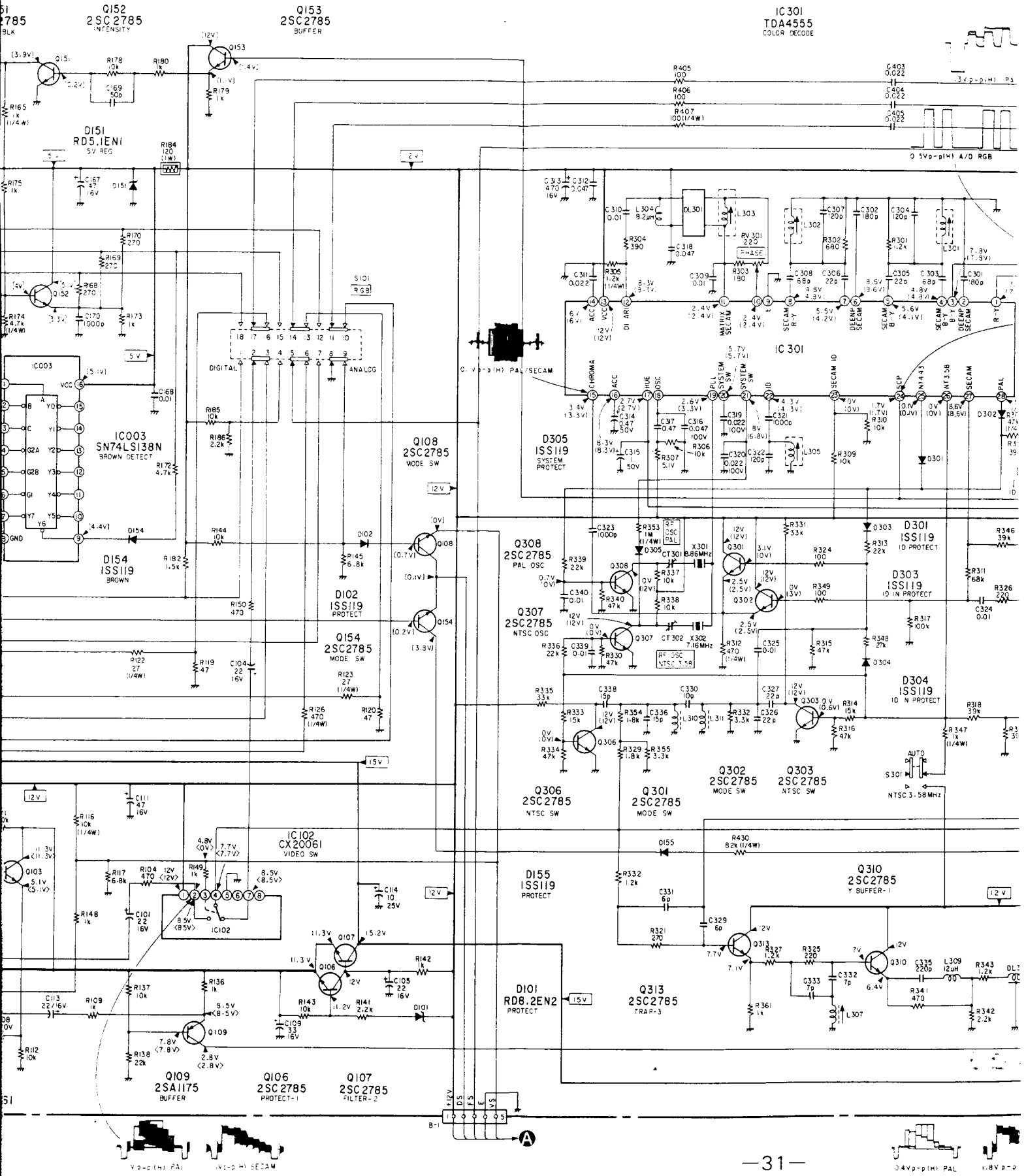

V-D (H) PAL V-D (H) SECAM

0.5Vp-p (H) A/D RGB 1.8V D-D

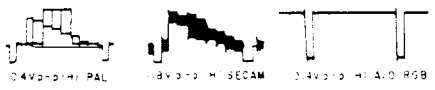
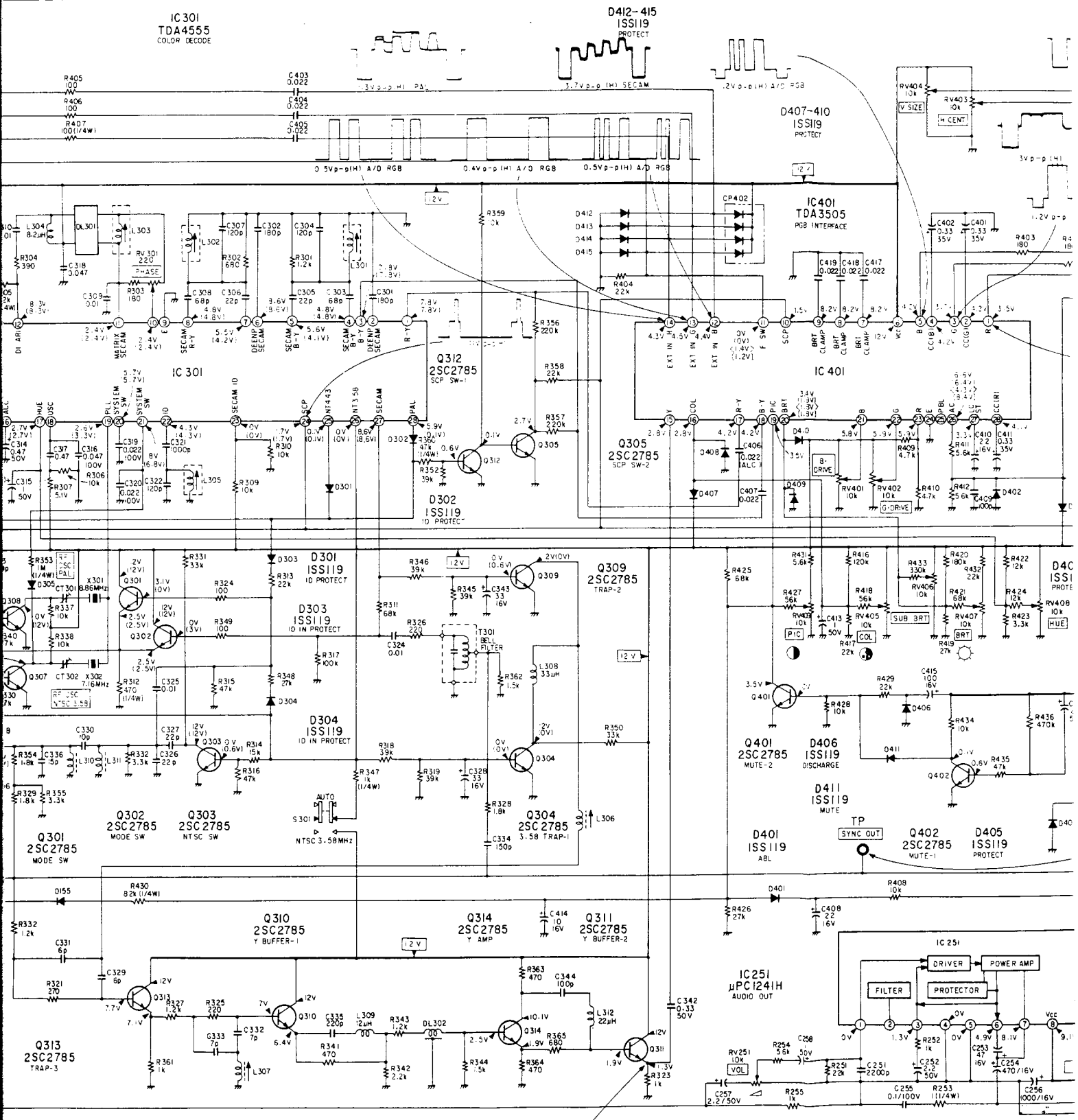

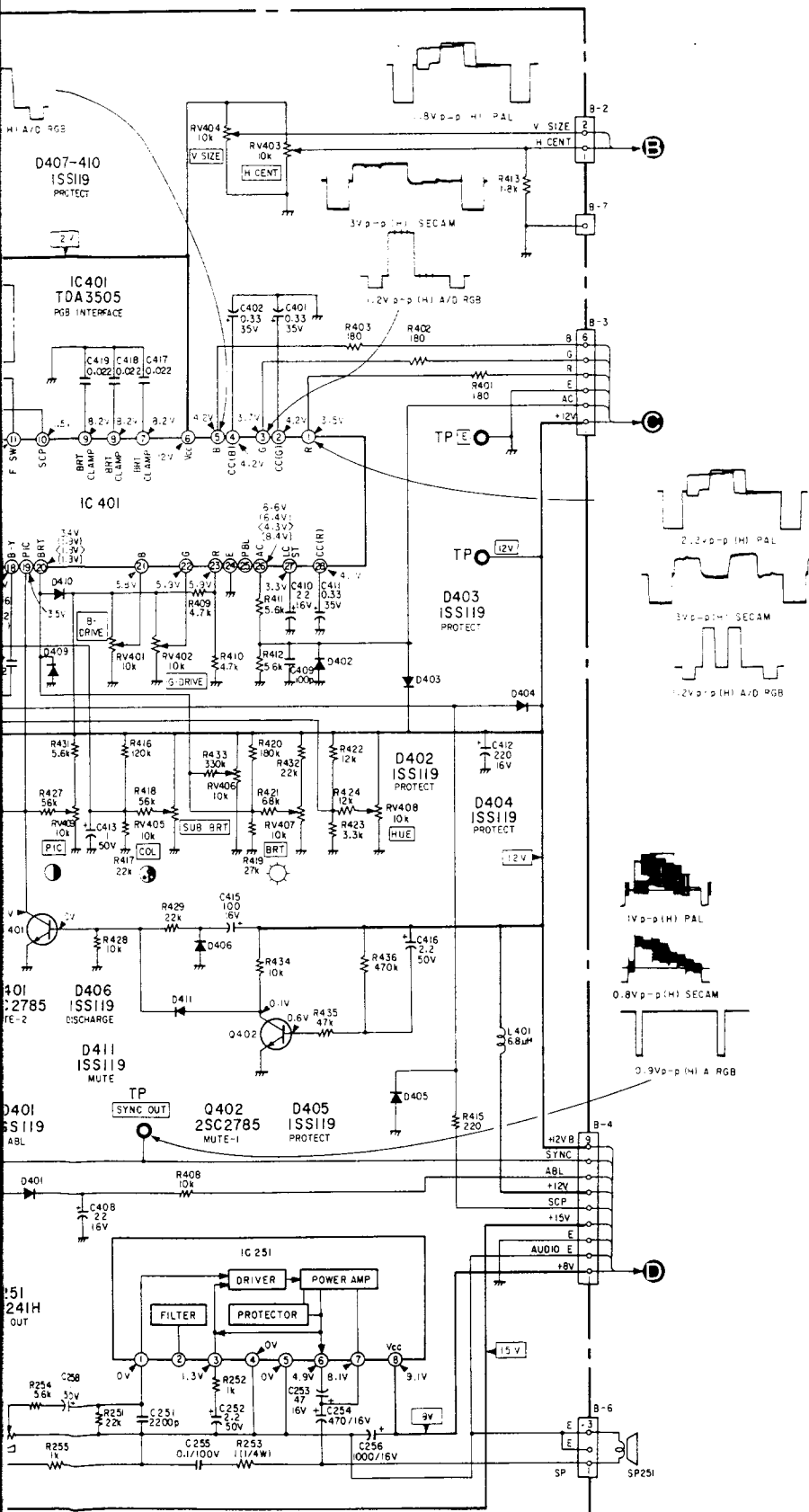

1 2 3 4 5 6 7 8

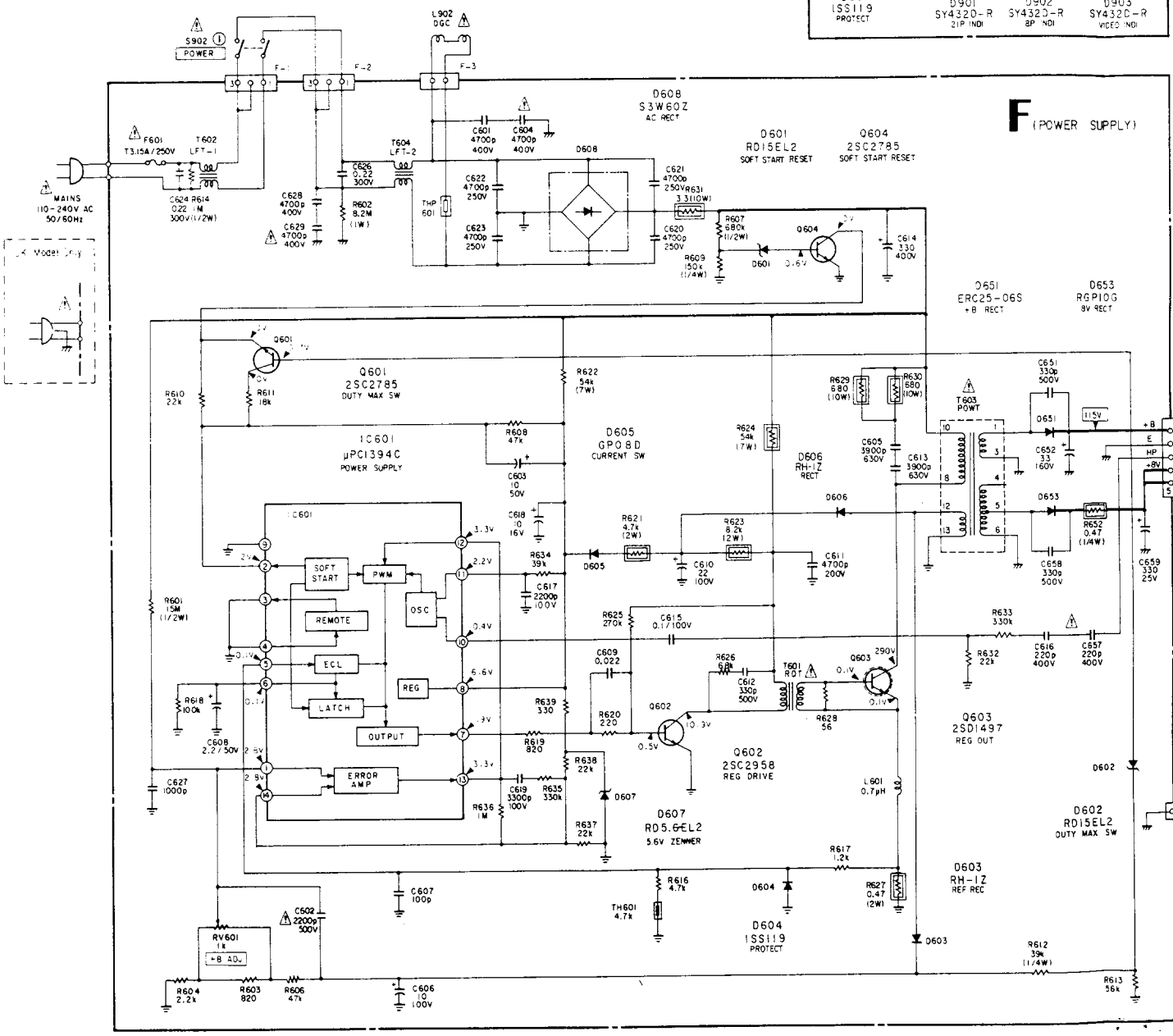
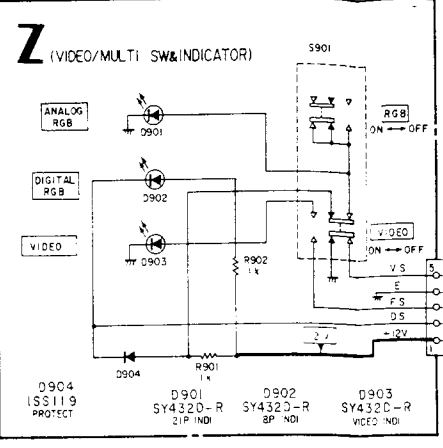

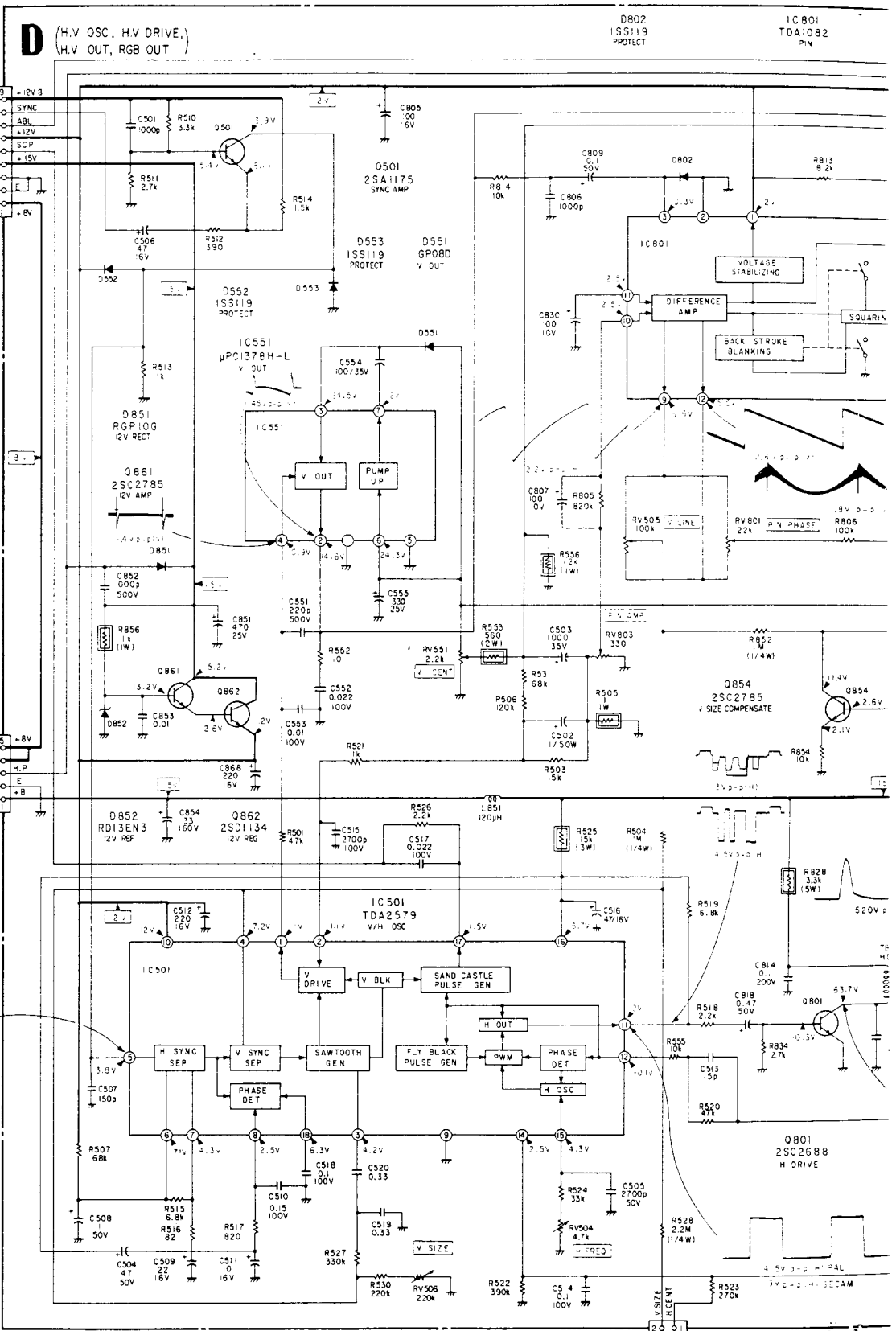
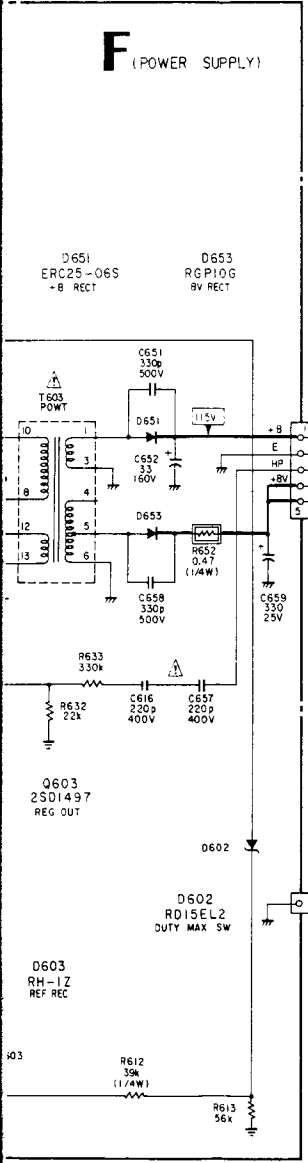
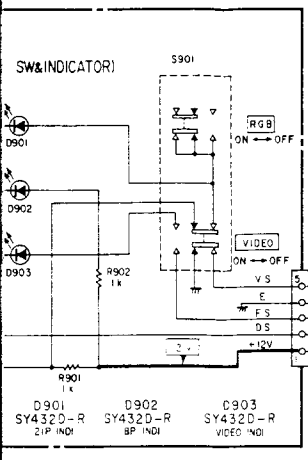

D802
ISS119
PROTECT

IC801
TDA1082
P.W.

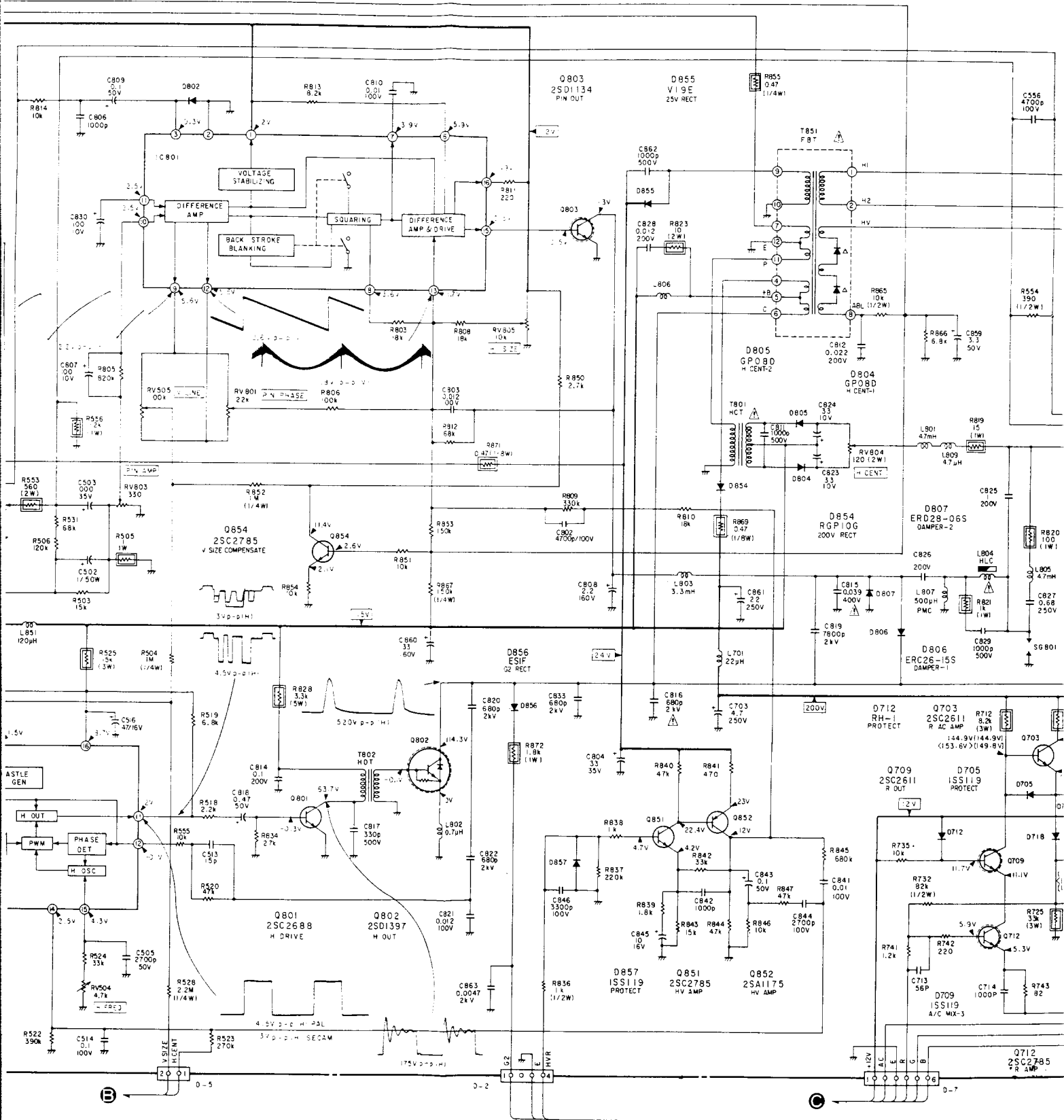

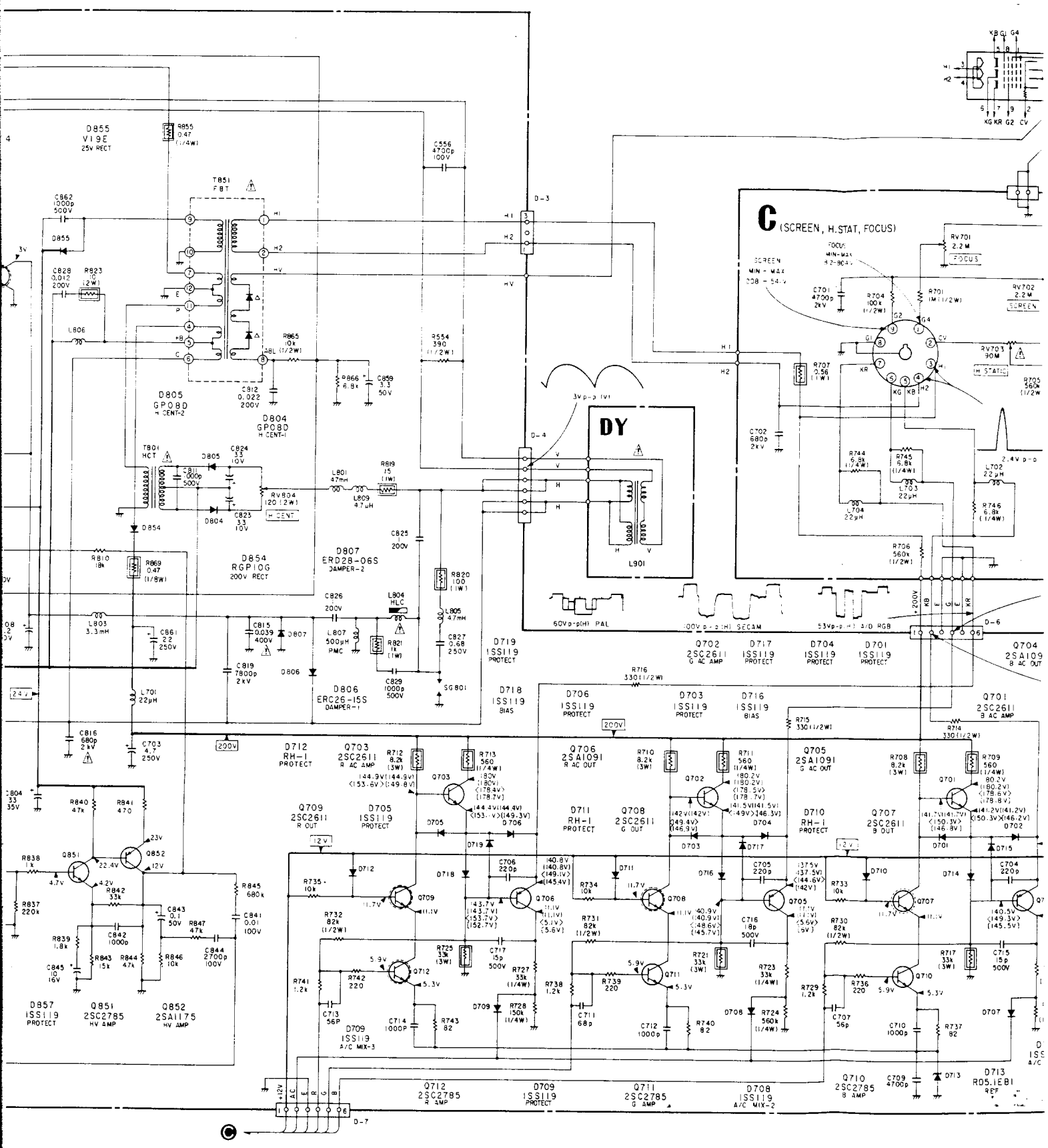

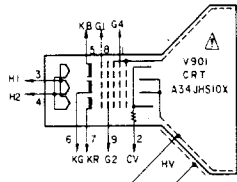

Note: The components identified by shading and mark are critical for safety. Replace only with part number specified.

Note: Les composants identifiés par une trame et par une marque sont d'une importance critique pour la sécurité. Ne les remplacer que par des pièces de numéro spécifié.

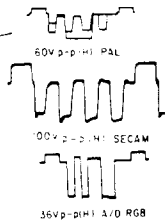
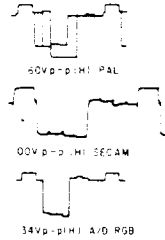
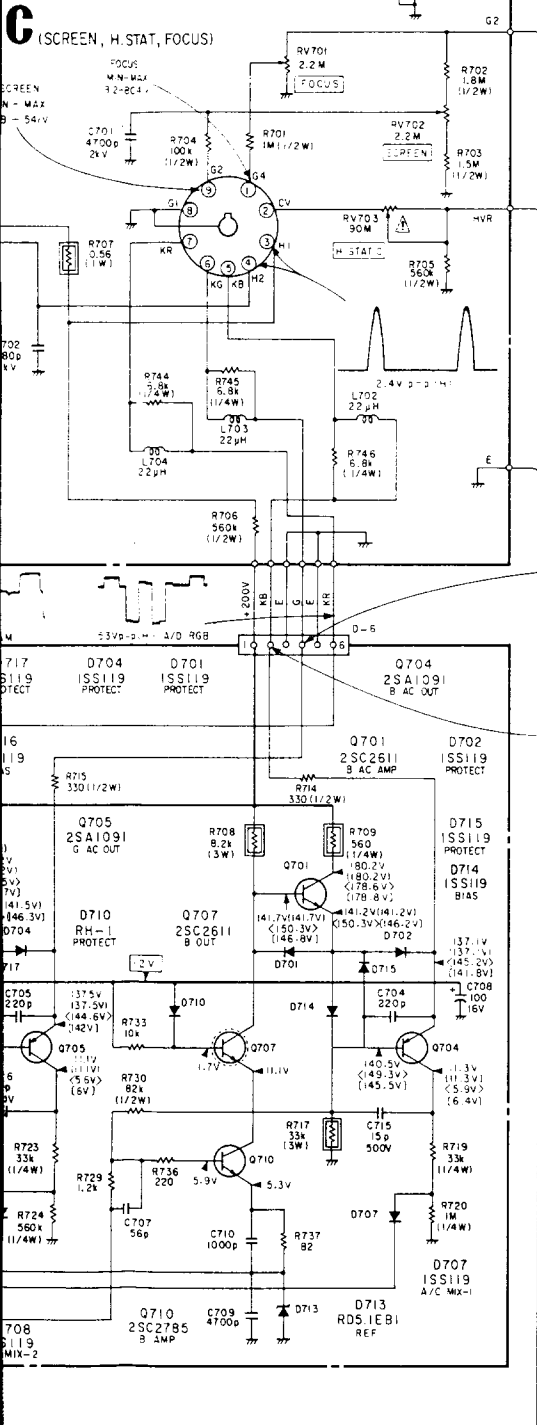

- All capacitors are in μF unless otherwise noted. ρ : μF 50WV or less are not indicated except for electrolytics.
- All resistors are in ohms, 1/6W unless otherwise noted. $\text{k}\Omega = 1000\Omega$, $\text{M}\Omega = 1000\text{k}\Omega$
- : nonflamable resistor.
- : fusible resistor
- Δ : internal component.
- : panel designation.
- All variable and adjustable resistors have characteristic curve B, unless otherwise noted.
- : adjustment for repair.
- Voltages are dc with respect to ground unless otherwise noted.
- Voltage variations may be noted due to normal production tolerances.
- Readings are taken with a 10M Ω digital multimeter.
- Readings are taken with a color-bar signal input.
- no mark : PAL or common
 () : SECAM
 < > : ANALOG RGB
 [] : DIGITAL RGB
- * : Can not be measured.
- : B + bus.
- : B - bus.
- : Selected to yield optimum performance.

For Service Manuals
MAURITRON SERVICES
 8 Cherry Tree Road, Chinnor
 Oxfordshire, OX9 4QY.
 Tel (01844) 351694
 Fax (01844) 352554
 email: mauritron@dial.pipex.com

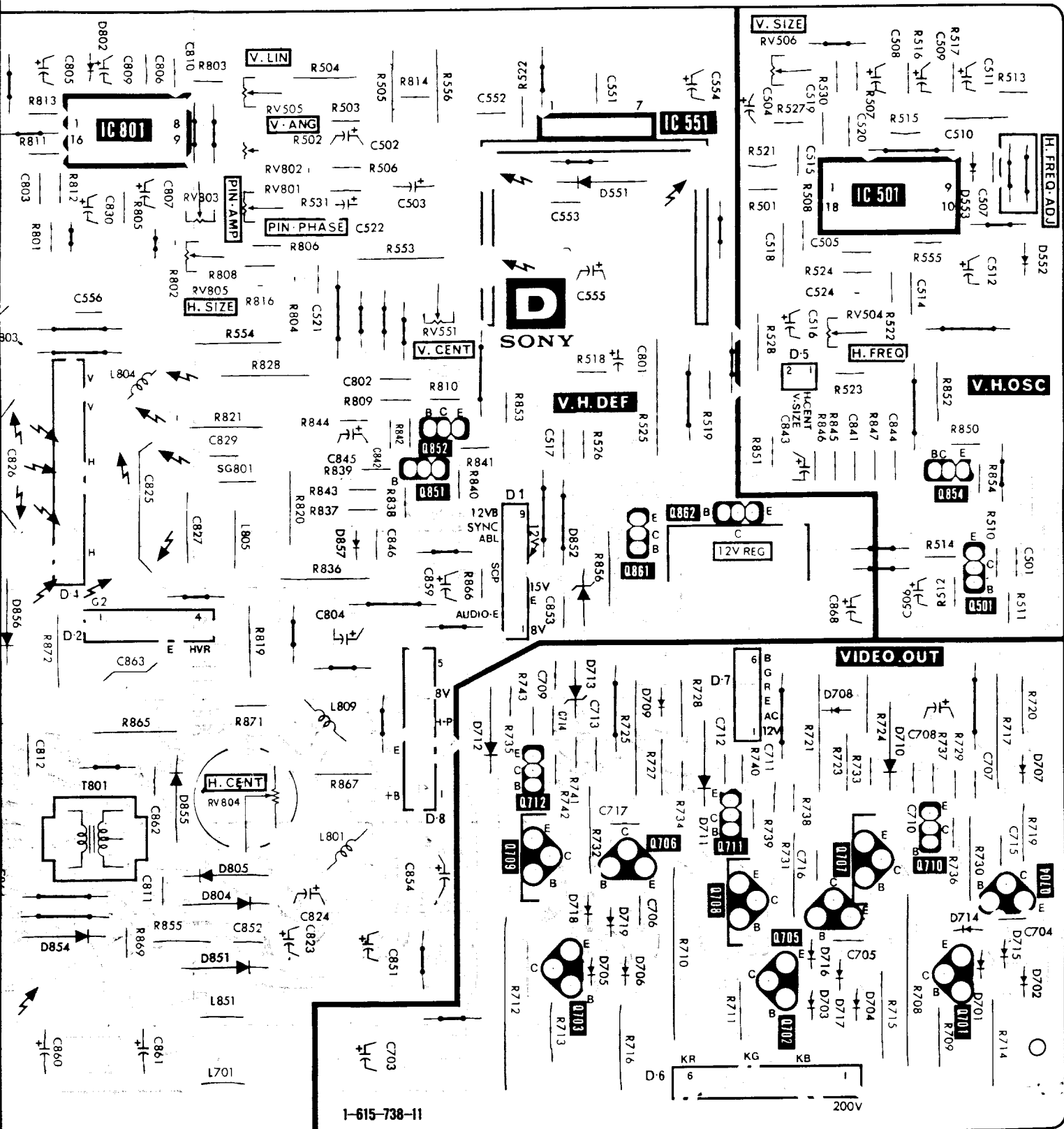

F Board

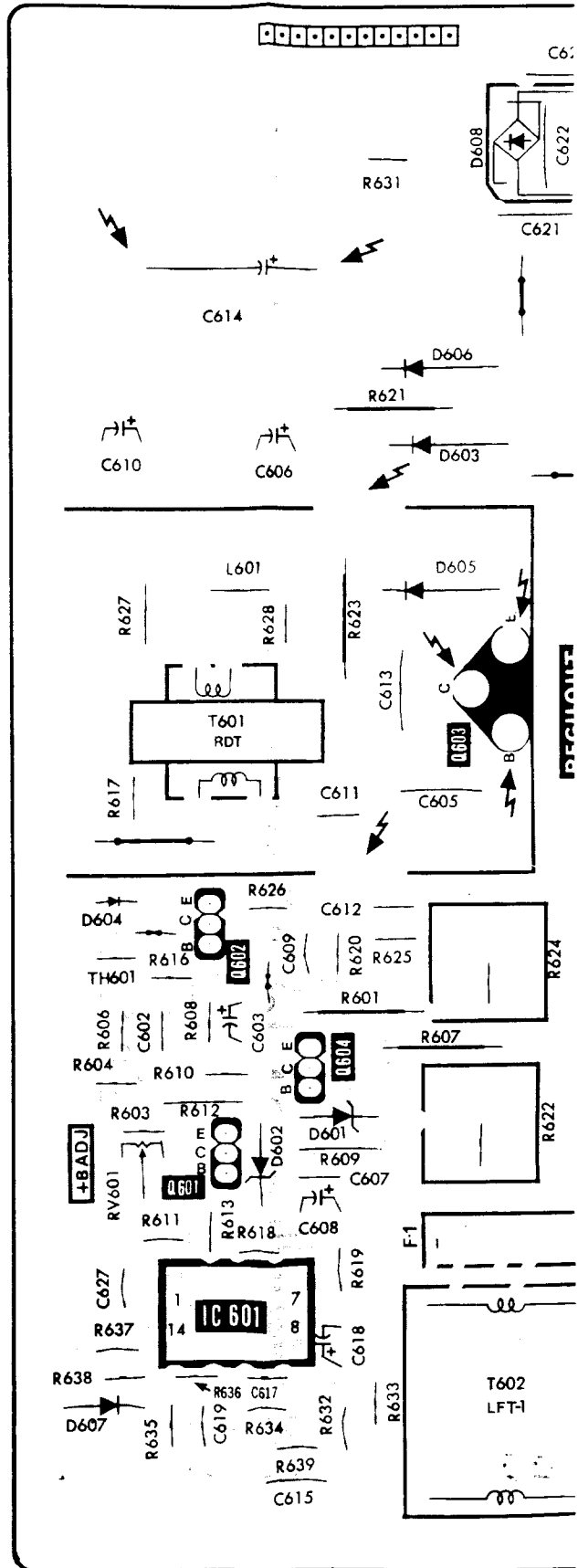
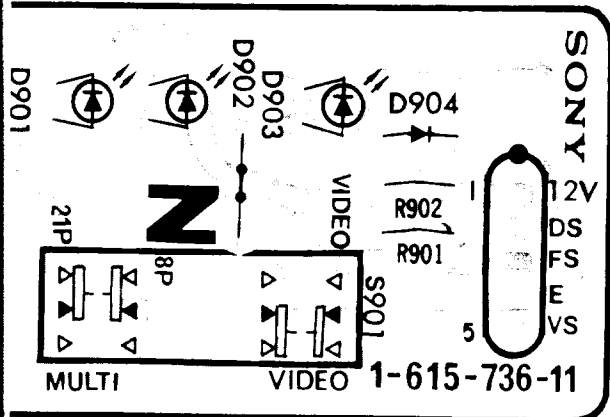
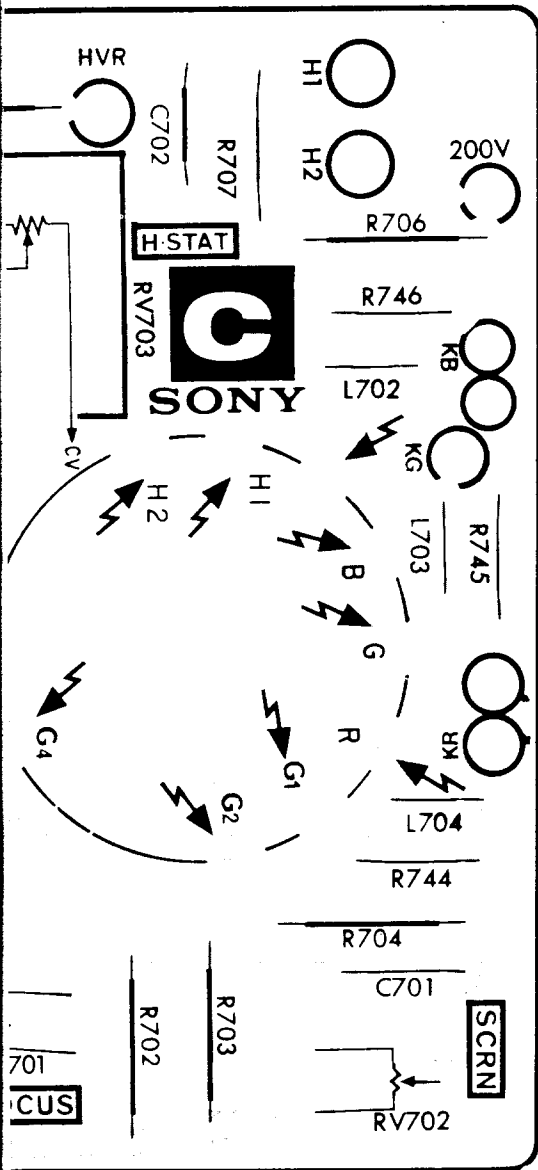

KX-14CP1 KX-14CP1

B CHROMA, SYNC OUT,
Y, RGB MATRIX, MODE SW

— B Board —

IC 0	D	ADJ
306	109	RV251
303	102	
IC251	105	
IC101		
313	303	RV409
304	304	
309	IC003	
101,104	154	
IC102		
308	310	RV407
301	305	RV406
302	156	
	155	
IC002		
154		
312	301	CV301
305	302	RV405
311	404	
	152	
IC301		RV408
	405	RV403
IC001		RV301
		RV404
103	414	
152	151	
IC401	413, 102	
108	412, 101	
	415,	
106	153	
107	151	
401	410, 409	
402	402, 408, 407	
	401	RV401
	403	RV402
	406, 411	

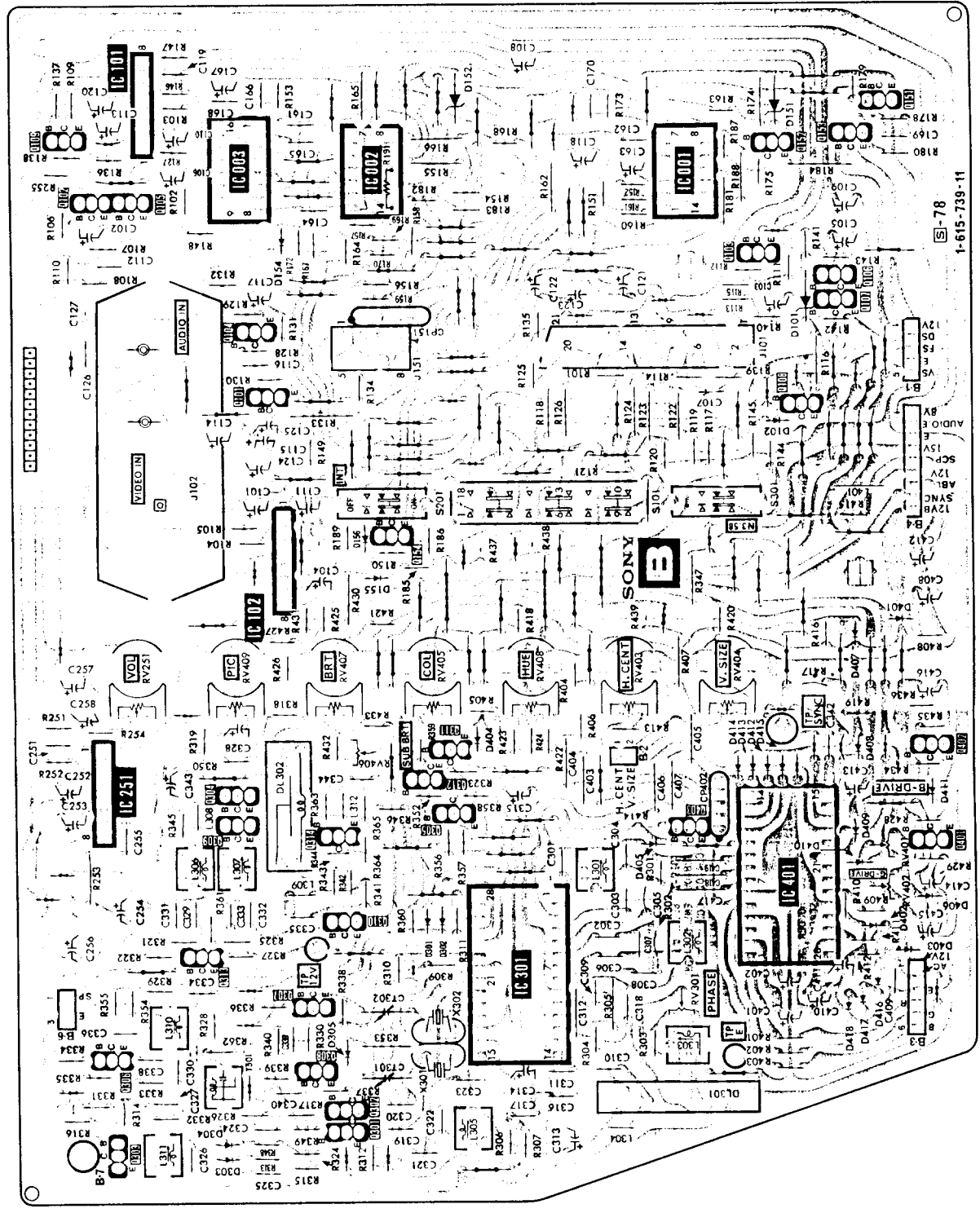

B [CHROMA, SYNC OUT,
Y/RGB MATRIX, MODE SW]

1 2 3 4 5 6 7 8

— B Board —

A	IC: Q	D	ADJ
B	306 109 303 102 IC251 105 IC101		RV251
C	313 304 303 309 304 IC003 101,104 154 IC102		RV409
D	308 310 307 310 301 305 302 156 IC002 155 154		RV407 RV406
E	312 301 305 302 311 404		RV405
F	IC301 152		RV408
G	IC001 405		RV301 RV404
H	103 414 151 IC401 413 152 108 412 102 106 415, 101 107 153 151		RV401 RV402
I	401 403 402 406,411		

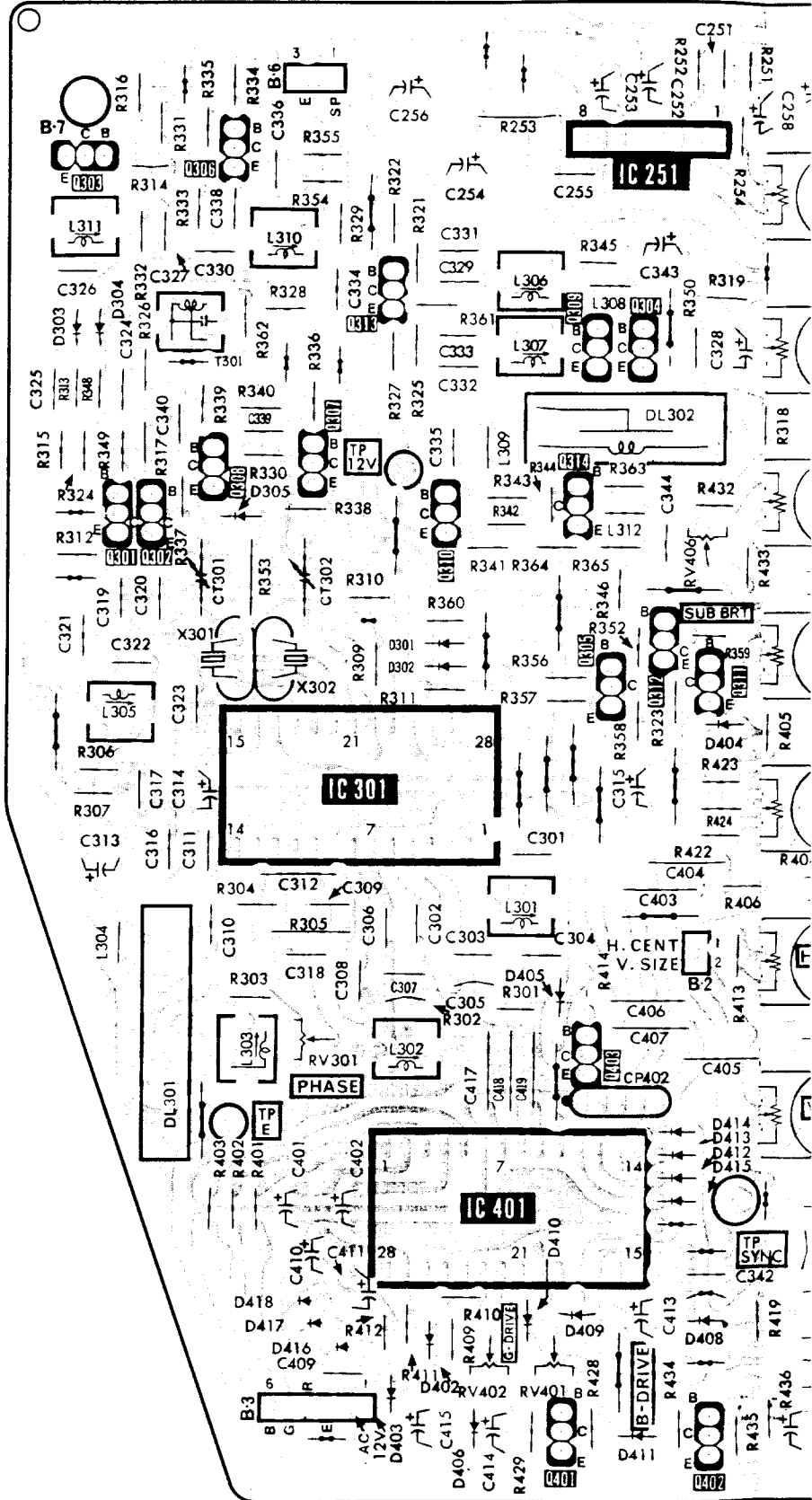

4 5 6 7 8 9 10 11 12

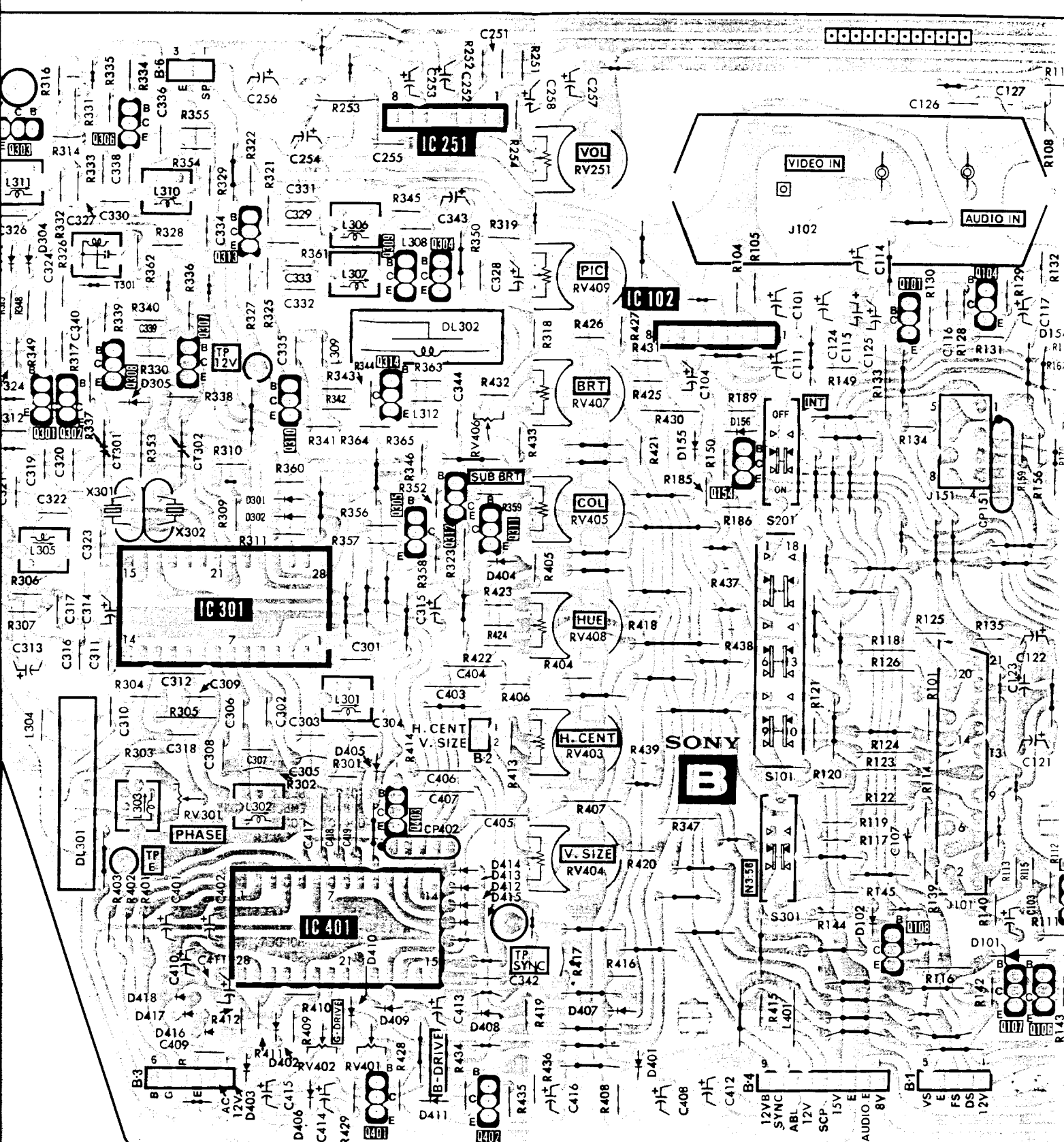

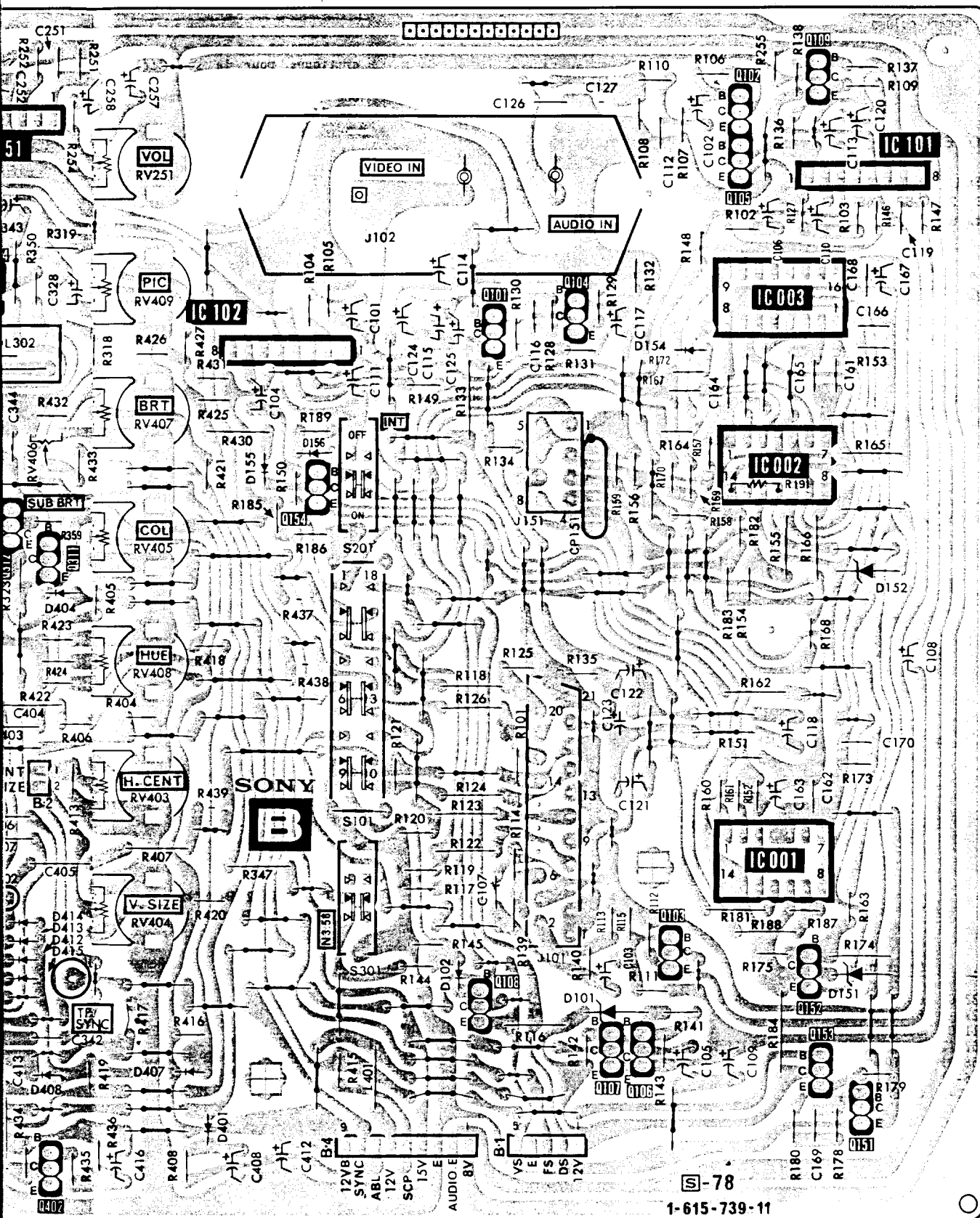

S-78
1-615-739-11

SECTION 6 EXPLODED VIEWS

NOTE:

- Items with no part number and no description are not stocked because they are seldom required for routine service.
- The construction parts of an assembled part are indicated with a collation number in the remark column.

- Items marked " * " are not stocked since they are seldom required for routine service. Some delay should be anticipated when ordering these items.

The components identified by shading and mark are critical for safety. Replace only with part number specified.

Les composants identifiés par une trame et une marque sont critiques pour la sécurité. Ne les remplacer que par une pièce portant le numéro spécifié.

**For Service Manuals
MAURITRON SERVICES**
8 Cherry Tree Road, Chinnor
Oxfordshire, OX9 4QY.
Tel (01844) 351694
Fax (01844) 352554
email:- mauritron@dial.pipex.com

6-1. REAR COVER

- : TA, BV 3x8 7-685-646-71
- : TA, BV 3x12 7-685-648-71
- ▲ : TA, BV 4x16 7-685-663-71

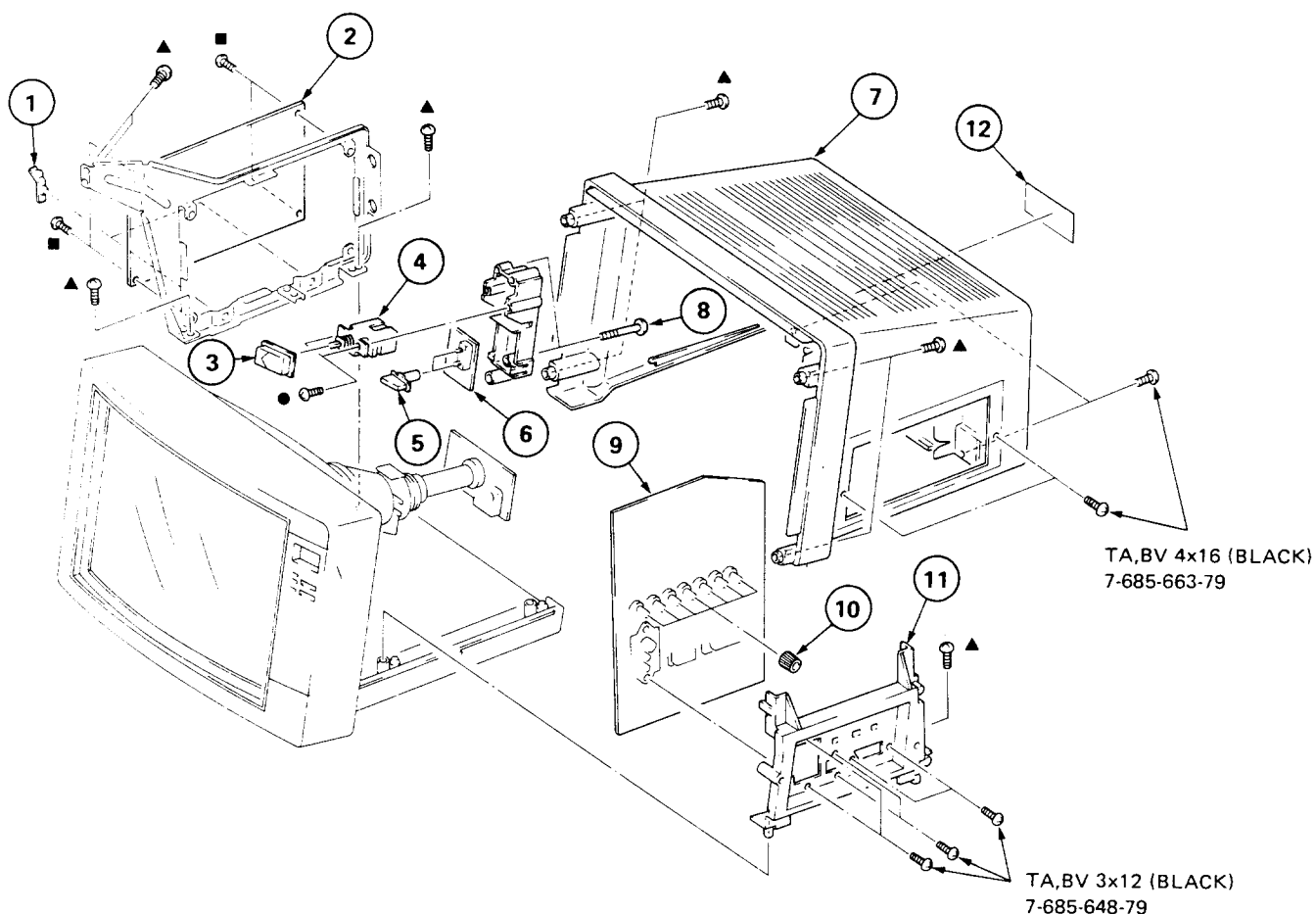

No.	Part No.	Description	Remark	No.	Part No.	Description	Remark
1	*4-313-732-00	CLIP, HINGE, CIRCUIT BOARD		8	3-703-083-00	+ BV 3X25	
2	*A-1245-279-A	F BOARD, COMPLETE		9	*A-1135-314-A	B BOARD, COMPLETE	
3	4-372-011-01	BUTTON, POWER		10	4-372-006-01	KNOB, CONTROL	
4	▲.1-554-967-11	SWITCH, PUSH (AC POWER)(1 KEY)		11	*X-4372-018-1	BRACKET ASSY, B PC BOARD	
5	4-372-068-01	BUTTON		12	4-372-072-01	LABEL, MODEL NUMBER (FOR AEP MODEL)	
6	*1-615-736-11	Z BOARD			4-372-063-01	LABEL, MODEL NUMBER (FOR UK MODEL)	
7	X-4372-020-1	COVER ASSY, REAR			4-372-075-01	LABEL, MODEL NUMBER (FOR F MODEL)	

6-2. CRT

- : TA, BV 3x12 7-685-648-71
- ▲ : TA, BV 4x16 7-685-663-71

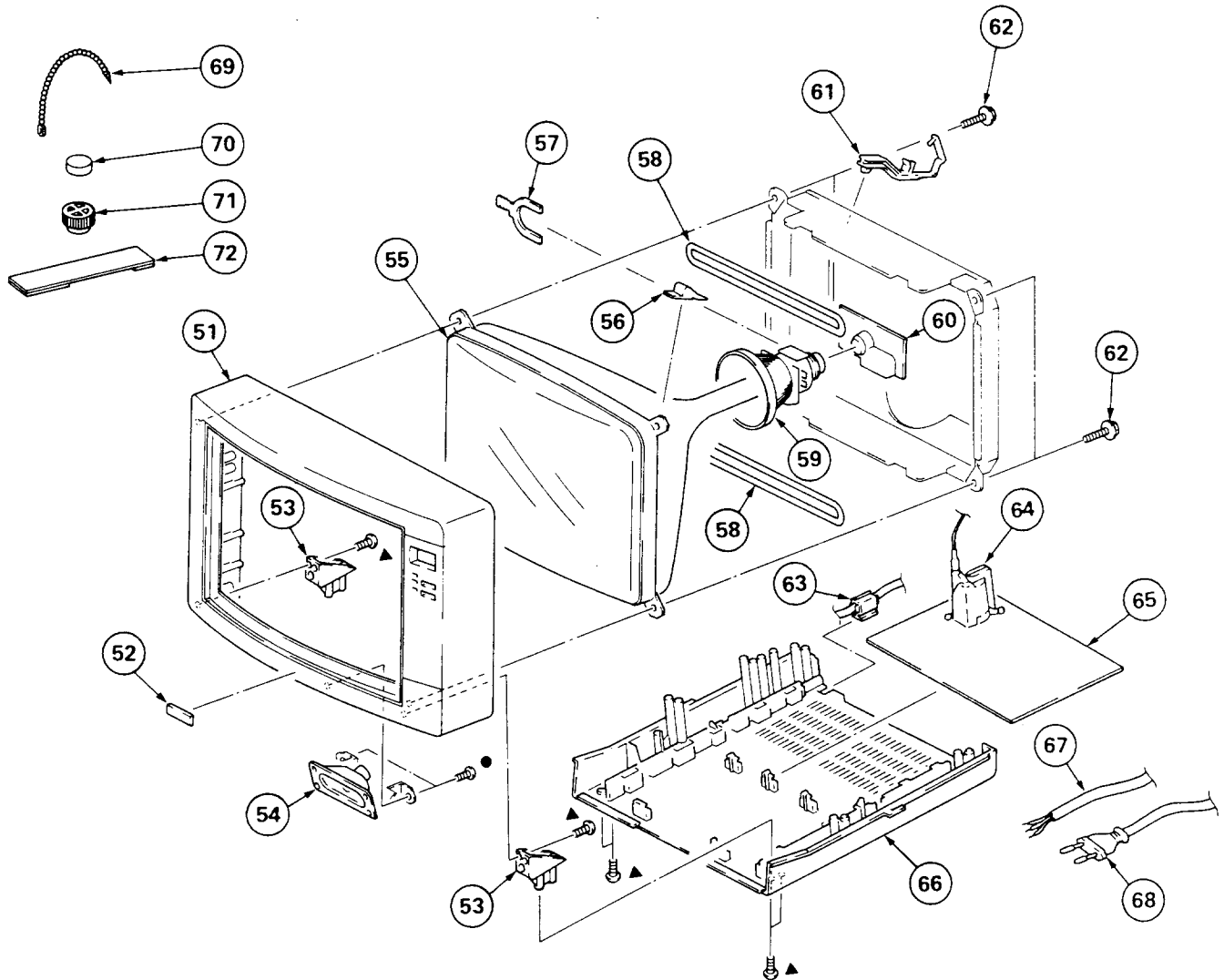

No.	Part No.	Description	Remark	No.	Part No.	Description	Remark
51	X-4372-019-1	BEZEL ASSY		63	▲.4-022-115-01	HOLDER, AC CORD (FOR AEP/F MODEL)	
52	4-836-828-00	EMBLEM, SONY	52	▲.4-364-745-01	BUSHING, AC CORD (FOR UK MODEL)		
53	4-372-004-01	CONNECTOR, BEZEL		64	▲.1-439-311-22	TRANSFORMER ASSY, FLYBACK	
54	1-503-239-00	SPEAKER		65	*A-1345-538-A	D BOARD, COMPLETE	
55	▲.8-736-252-05	CRT (A34JHS10X)		66	4-372-026-31	CABINET (BOTTOM BLOCK)	
56	3-703-961-01	SPACER, DY		67	▲.1-534-820-13	POWER CORD (FOR UK MODEL)	
57	1-452-277-00	MAGNET, BMC		68	▲.1-551-427-21	CORD, POWER, EULO PLUG (FOR AEP/F MODEL)	
58	▲.1-426-145-12	COIL, DEGAUSSING		69	4-308-870-00	CLIP, LEAD WIRE	
59	▲.1-451-250-11	DEFLECTION YOKE (SY-154)		70	1-452-032-00	MAGNET, DISK; 10MM ∅	
60	*A-1330-619-A	C BOARD, COMPLETE		71	1-452-094-00	MAGNET, ROTATABLE DISK; 15MM ∅	
61	*4-346-339-00	HOLDER, HV CABLE		72	X-4309-608-0	PERMALLOY ASSY, CONVERGENCE	
62	4-365-808-00	SCREW (5), TAPPING					

The components identified by shading and mark ▲ are critical for safety. Replace only with part number specified.

Les composants identifiés par une trame et une marque ▲ sont critiques pour la sécurité. Ne les remplacer que par une pièce portant le numéro spécifié.

SECTION 7 ELECTRICAL PARTS LIST

B

NOTE:

The components identified by shading and mark Δ are critical for safety. Replace only with part number specified.

Les composants identifiés par une trame et une marque Δ sont critiques pour la sécurité. Ne les remplacer que par une pièce portant le numéro spécifié.

• Items marked " " are not stocked since they are seldom required for routine service. Some delay should be anticipated when ordering these items.

• All variable and adjustable resistors have characteristic curve B, unless otherwise noted.

CAPACITORS

• MF : μ F, PF : μ F

When indicating parts by reference number, please include the board name.

RESISTORS

• All resistors are in ohms
• F : nonflammable

COILS

• MMH : mH, UH : μ H

Ref.No.	Part No.	Description	Remark	Ref.No.	Part No.	Description	Remark
	*A-1135-314-A	B BOARD, COMPLETE *****		C301	1-102-109-00	CERAMIC 180PF	10% 50V
				C302	1-102-109-00	CERAMIC 180PF	10% 50V
				C303	1-102-525-00	CERAMIC 68PF	5% 50V
				C304	1-102-735-00	CERAMIC 120PF	5% 50V
				C305	1-102-514-00	CERAMIC 22PF	5% 50V
		<u>CONNECTOR</u>		C306	1-102-514-00	CERAMIC 22PF	5% 50V
B1	*1-560-278-00	PLUG, CONNECTOR 5P		C307	1-102-735-00	CERAMIC 120PF	5% 50V
B2	*1-560-290-00	PLUG, CONNECTOR (2.5MM PITCH)		C308	1-102-525-00	CERAMIC 68PF	5% 50V
B3	*1-560-278-00	PLUG, CONNECTOR 6P		C309	1-101-004-00	CERAMIC 0.01MF	50V
B4	*1-560-278-00	PLUG, CONNECTOR 9P		C310	1-101-004-00	CERAMIC 0.01MF	50V
B6	*1-560-123-00	PLUG, CONNECTOR (2.5MM PITCH)					
		<u>CAPACITOR</u>		C311	1-161-055-00	CERAMIC 0.022MF	10% 50V
C101	1-123-622-00	ELECT 22MF	20% 16V	C312	1-101-006-21	CERAMIC 0.047MF	50V
C102	1-123-611-00	ELECT 1MF	20% 50V	C313	1-123-323-00	ELECT 470MF	20% 16V
C103	1-123-611-00	ELECT 1MF	20% 50V	C314	1-123-379-00	ELECT 0.47MF	20% 50V
C104	1-123-622-00	ELECT 22MF	20% 16V	C315	1-123-380-00	ELECT 1MF	20% 50V
C105	1-123-622-00	ELECT 22MF	20% 16V				
C106	1-123-318-00	ELECT 33MF	20% 16V	C316	1-108-634-81	MYLAR 0.047MF	10% 100V
C107	1-102-114-00	CERAMIC 470PF	10% 50V	C317	1-136-173-00	FILM 0.47MF	5% 50V
C108	1-123-380-00	ELECT 1MF	20% 50V	C318	1-101-006-21	CERAMIC 0.047MF	50V
C109	1-123-820-00	ELECT 33MF	20% 16V	C319	1-106-204-00	MYLAR 0.022MF	10% 100V
C110	1-123-380-00	ELECT 1MF	20% 50V	C320	1-106-204-00	MYLAR 0.022MF	10% 100V
C111	1-123-821-00	ELECT 47MF	20% 16V	C321	1-102-074-00	CERAMIC 0.001MF	10% 50V
C112	1-102-114-00	CERAMIC 470PF	10% 50V	C322	1-102-679-00	CERAMIC 120PF	5% 50V
C113	1-123-330-00	ELECT 22MF	20% 16V	C323	1-102-074-00	CERAMIC 0.001MF	10% 50V
C114	1-123-620-00	ELECT 10MF	20% 25V	C324	1-101-004-00	CERAMIC 0.01MF	50V
C116	1-101-884-00	CERAMIC 56PF	10% 50V	C325	1-101-004-00	CERAMIC 0.01MF	50V
C117	1-123-617-00	ELECT 10MF	20% 16V	C326	1-102-892-00	CERAMIC 22PF	5% 50V
C118	1-123-309-00	ELECT 330MF	20% 10V	C327	1-102-892-00	CERAMIC 22PF	5% 50V
C119	1-102-074-00	CERAMIC 0.001MF	10% 50V	C328	1-123-318-00	ELECT 33MF	20% 16V
C120	1-123-330-00	ELECT 22MF	20% 16V	C329	1-102-857-00	CERAMIC 6PF	0.5PF 50V
C121	1-123-821-00	ELECT 47MF	20% 16V	C330	1-102-858-00	CERAMIC 10PF	0.5PF 50V
C122	1-123-821-00	ELECT 47MF	20% 16V	C331	1-102-857-00	CERAMIC 6PF	0.5PF 50V
C124	1-123-821-00	ELECT 47MF	20% 16V	C332	1-102-662-00	CERAMIC 7PF	0.5PF 50V
C125	1-123-821-00	ELECT 47MF	20% 16V	C333	1-102-662-00	CERAMIC 7PF	0.5PF 50V
C126	1-102-114-00	CERAMIC 470PF	10% 50V	C334	1-102-108-00	CERAMIC 150PF	10% 50V
C161	1-101-877-91	CERAMIC 39PF	10% 50V	C335	1-102-978-00	CERAMIC 220PF	5% 50V
C162	1-101-004-00	CERAMIC 0.01MF	50V	C336	1-102-668-00	CERAMIC 15PF	5% 50V
C163	1-123-332-00	ELECT 47MF	20% 16V	C338	1-102-668-00	CERAMIC 15PF	5% 50V
C164	1-101-877-91	CERAMIC 39PF	10% 50V	C339	1-101-004-00	CERAMIC 0.01MF	50V
C165	1-101-877-91	CERAMIC 39PF	10% 50V	C340	1-101-004-00	CERAMIC 0.01MF	50V
C166	1-101-877-91	CERAMIC 39PF	10% 50V	C342	1-136-171-00	FILM 0.33MF	5% 50V
C167	1-123-332-00	ELECT 47MF	20% 16V	C343	1-123-318-00	ELECT 33MF	20% 16V
C168	1-101-004-00	CERAMIC 0.01MF	50V	C344	1-102-973-00	CERAMIC 100PF	5% 50V
C169	1-101-361-00	CERAMIC 150PF	5% 50V	C401	1-131-344-00	TANTALUM 0.33MF	10% 35V
C170	1-102-074-00	CERAMIC 0.001MF	10% 50V	C402	1-131-344-00	TANTALUM 0.33MF	10% 35V
C251	1-102-121-00	CERAMIC 0.0022MF	10% 50V	C403	1-161-494-00	CERAMIC 0.022MF	30% 25V
C252	1-123-612-00	ELECT 2.2MF	20% 50V	C404	1-161-494-00	CERAMIC 0.022MF	30% 25V
C253	1-123-821-00	ELECT 47MF	20% 16V	C405	1-161-494-00	CERAMIC 0.022MF	30% 25V
C254	1-123-323-00	ELECT 470MF	20% 16V	C406	1-161-494-00	CERAMIC 0.022MF	30% 25V
C255	1-106-220-00	MYLAR 0.1MF	10% 100V	C407	1-161-494-00	CERAMIC 0.022MF	30% 25V
C256	1-123-324-00	ELECT 1000MF	20% 16V	C408	1-123-622-00	ELECT 22MF	20% 16V
C257	1-123-381-00	ELECT 2.2MF	20% 50V	C409	1-102-973-00	CERAMIC 100PF	5% 50V
C258	1-123-611-00	ELECT 1MF	20% 50V	C410	1-123-330-00	ELECT 22MF	20% 16V
				C411	1-131-344-00	TANTALUM 0.33MF	10% 35V

B

Ref.No.	Part No.	Description	Remark	Ref.No.	Part No.	Description	Remark
C412	1-123-321-00	ELECT	220MF 20% 16V	IC251	8-759-101-77	IC UPC1241H	
C413	1-123-380-00	ELECT	1MF 20% 50V	IC301	8-759-915-57	IC TDA4555	
C414	1-123-617-00	ELECT	10MF 20% 16V	IC401	8-759-911-10	IC TDA3505	
C415	1-123-333-00	ELECT	100MF 20% 16V				
C416	1-123-612-00	ELECT	2.2MF 20% 50V			JACK	
C417	1-161-494-00	CERAMIC	0.022MF 30% 25V	J101	1-561-534-41	SOCKET 21P	
C418	1-161-494-00	CERAMIC	0.022MF 30% 25V	J102	1-536-929-11	TERMINAL BOARD, INPUT/OUTPUT	
C419	1-161-494-00	CERAMIC	0.022MF 30% 25V	J151	1-561-577-21	CONNECTOR (DIP TYPE) 8P	
		TRIMMER				COIL	
CT301	1-141-181-11	CAP, TRIMMER		L301	1-404-554-11	COIL	
CT302	1-141-181-11	CAP, TRIMMER		L302	1-404-554-11	COIL	
		DIODE		L303	1-404-539-11	COIL	
D101	8-719-102-84	DIODE RD8.2E-N2		L304	1-408-408-00	MICRO INDUCTOR 8.2UH	
D102	8-719-911-19	DIODE 1SS119		L305	1-404-554-11	COIL	
D151	8-719-102-67	DIODE RD5.1E-N1		L306	1-404-495-00	COIL	
D152	8-719-100-37	DIODE RD6.2E-B1		L307	1-404-495-00	COIL	
D154	8-719-911-19	DIODE 1SS119		L308	1-408-448-31	MICRO INDUCTOR 33UH	
D155	8-719-911-19	DIODE 1SS119		L309	1-408-410-00	MICRO INDUCTOR 12UH	
D156	8-719-911-19	DIODE 1SS119		L310	1-404-494-00	COIL	
D301	8-719-911-19	DIODE 1SS119		L311	1-404-494-00	COIL	
D302	8-719-911-19	DIODE 1SS119		L312	1-408-413-00	MICRO INDUCTOR 22UH	
D303	8-719-911-19	DIODE 1SS119		L401	1-408-300-00	MICRO INDUCTOR 6.8UH	
D304	8-719-911-19	DIODE 1SS119				TRANSISTOR	
D305	8-719-911-19	DIODE 1SS119		Q101	8-729-177-43	TRANSISTOR 2SD774	
D401	8-719-911-19	DIODE 1SS119		Q102	8-729-245-83	TRANSISTOR 2SC2458	
D402	8-719-911-19	DIODE 1SS119		Q103	8-729-245-83	TRANSISTOR 2SC2458	
D403	8-719-911-19	DIODE 1SS119		Q104	8-729-245-83	TRANSISTOR 2SC2458	
D404	8-719-911-19	DIODE 1SS119		Q105	8-729-245-83	TRANSISTOR 2SC2458	
D405	8-719-911-19	DIODE 1SS119		Q106	8-729-245-83	TRANSISTOR 2SC2458	
D406	8-719-911-19	DIODE 1SS119		Q107	8-729-245-83	TRANSISTOR 2SC2458	
D407	8-719-911-19	DIODE 1SS119		Q108	8-729-245-83	TRANSISTOR 2SC2458	
D408	8-719-911-19	DIODE 1SS119		Q109	8-729-204-83	TRANSISTOR 2SA1048GR	
D409	8-719-911-19	DIODE 1SS119		Q151	8-729-245-83	TRANSISTOR 2SC2458	
D410	8-719-911-19	DIODE 1SS119		Q152	8-729-245-83	TRANSISTOR 2SC2458	
D411	8-719-911-19	DIODE 1SS119		Q153	8-729-245-83	TRANSISTOR 2SC2458	
D412	8-719-911-19	DIODE 1SS119		Q154	8-729-245-83	TRANSISTOR 2SC2458	
D413	8-719-911-19	DIODE 1SS119		Q301	8-729-245-83	TRANSISTOR 2SC2458	
D414	8-719-911-19	DIODE 1SS119		Q302	8-729-245-83	TRANSISTOR 2SC2458	
D415	8-719-911-19	DIODE 1SS119		Q303	8-729-245-83	TRANSISTOR 2SC2458	
		DELAY LINE		Q304	8-729-245-83	TRANSISTOR 2SC2458	
DL301	1-415-122-31	DELAY LINE, 1H (PAL)		Q305	8-729-245-83	TRANSISTOR 2SC2458	
DL302	1-415-330-00	DELAY LINE, Y		Q306	8-729-245-83	TRANSISTOR 2SC2458	
		IC		Q307	8-729-245-83	TRANSISTOR 2SC2458	
IC001	8-759-900-86	IC SN74LS86N		Q308	8-729-245-83	TRANSISTOR 2SC2458	
IC002	8-759-900-09	IC SN74LS09N		Q309	8-729-245-83	TRANSISTOR 2SC2458	
IC003	8-759-901-38	IC SN74LS138N		Q310	8-729-245-83	TRANSISTOR 2SC2458	
IC101	8-752-006-10	IC CX20061		Q311	8-729-245-83	TRANSISTOR 2SC2458	
IC102	8-752-006-10	IC CX20061		Q312	8-729-245-83	TRANSISTOR 2SC2458	
				Q313	8-729-245-83	TRANSISTOR 2SC2458	
				Q314	8-729-245-83	TRANSISTOR 2SC2458	
				Q401	8-729-245-83	TRANSISTOR 2SC2458	

B

Ref.No.	Part No.	Description	Remark	Ref.No.	Part No.	Description	Remark
Q402	8-729-245-83	TRANSISTOR 2SC2458		R151	1-247-855-00	CARBON 10K 5%	1/6W
		RESISTOR		R152	1-247-855-00	CARBON 10K 5%	1/6W
R101	1-247-804-00	CARBON 75 5%	1/6W	R153	1-247-831-00	CARBON 1K 5%	1/6W
R102	1-247-819-00	CARBON 330 5%	1/6W	R154	1-247-823-00	CARBON 470 5%	1/6W
R103	1-247-831-00	CARBON 1K 5%	1/6W	R155	1-247-113-00	CARBON 180 5%	1/4W
R104	1-247-823-00	CARBON 470 5%	1/6W	R156	1-247-823-00	CARBON 470 5%	1/6W
R105	1-247-807-00	CARBON 100 5%	1/6W	R157	1-247-813-00	CARBON 180 5%	1/6W
R106	1-247-903-00	CARBON 1M 5%	1/6W	R158	1-247-813-00	CARBON 180 5%	1/6W
R107	1-247-903-00	CARBON 1M 5%	1/6W	R159	1-247-823-00	CARBON 470 5%	1/6W
R108	1-247-873-00	CARBON 56K 5%	1/6W	R160	1-247-813-00	CARBON 180 5%	1/6W
R109	1-247-831-00	CARBON 1K 5%	1/6W	R161	1-247-813-00	CARBON 180 5%	1/6W
R110	1-247-855-00	CARBON 10K 5%	1/6W	R162	1-247-113-00	CARBON 180 5%	1/4W
R111	1-247-879-00	CARBON 100K 5%	1/6W	R163	1-247-859-00	CARBON 15K 5%	1/6W
R112	1-247-855-00	CARBON 10K 5%	1/6W	R164	1-247-837-00	CARBON 1.8K 5%	1/6W
R113	1-247-863-00	CARBON 22K 5%	1/6W	R165	1-247-131-00	CARBON 1K 5%	1/4W
R114	1-247-863-00	CARBON 22K 5%	1/6W	R166	1-247-137-00	CARBON 1.8K 5%	1/4W
R115	1-247-879-00	CARBON 100K 5%	1/6W	R167	1-247-837-00	CARBON 1.8K 5%	1/6W
R116	1-247-155-00	CARBON 10K 5%	1/4W	R168	1-247-817-00	CARBON 270 5%	1/6W
R117	1-247-851-00	CARBON 6.8K 5%	1/6W	R169	1-247-817-00	CARBON 270 5%	1/6W
R118	1-247-123-00	CARBON 470 5%	1/4W	R170	1-247-817-00	CARBON 270 5%	1/6W
R119	1-247-799-00	CARBON 47 5%	1/6W	R172	1-247-847-00	CARBON 4.7K 5%	1/6W
R120	1-247-799-00	CARBON 47 5%	1/6W	R173	1-247-831-00	CARBON 1K 5%	1/6W
R121	1-247-799-00	CARBON 47 5%	1/6W	R174	1-247-147-00	CARBON 4.7K 5%	1/4W
R122	1-247-093-00	CARBON 27 5%	1/4W	R175	1-247-831-00	CARBON 1K 5%	1/6W
R123	1-247-093-00	CARBON 27 5%	1/4W	R178	1-247-855-00	CARBON 10K 5%	1/6W
R124	1-247-093-00	CARBON 27 5%	1/4W	R179	1-247-831-00	CARBON 1K 5%	1/6W
R125	1-247-804-00	CARBON 75 5%	1/6W	R180	1-247-831-00	CARBON 1K 5%	1/6W
R126	1-247-123-00	CARBON 470 5%	1/4W	R181	1-247-147-00	CARBON 4.7K 5%	1/4W
R127	1-247-823-00	CARBON 470 5%	1/6W	R182	1-247-835-00	CARBON 1.5K 5%	1/6W
R128	1-247-819-00	CARBON 330 5%	1/6W	R183	1-247-841-00	CARBON 2.7K 5%	1/6W
R129	1-247-819-00	CARBON 330 5%	1/6W	R184	1-216-427-00	METAL OXIDE 120 5%	1W F
R130	1-247-827-00	CARBON 680 5%	1/6W	R185	1-247-855-00	CARBON 10K 5%	1/6W
R131	1-247-843-00	CARBON 3.3K 5%	1/6W	R186	1-249-421-11	CARBON 2.2K 5%	1/6W
R132	1-247-831-00	CARBON 1K 5%	1/6W	R187	1-247-855-00	CARBON 10K 5%	1/6W
R133	1-216-429-00	METAL OXIDE 270 5%	1W F	R188	1-247-123-00	CARBON 470 5%	1/4W
R134	1-247-804-00	CARBON 75 5%	1/6W	R189	1-247-879-00	CARBON 100K 5%	1/6W
R135	1-247-855-00	CARBON 10K 5%	1/6W	R191	1-247-831-00	CARBON 1K 5%	1/6W
R136	1-247-831-00	CARBON 1K 5%	1/6W	R251	1-247-863-00	CARBON 22K 5%	1/6W
R137	1-247-855-00	CARBON 10K 5%	1/6W	R252	1-247-831-00	CARBON 1K 5%	1/6W
R138	1-247-863-00	CARBON 22K 5%	1/6W	R253	1-249-447-11	CARBON 1 5%	1/4W
R139	1-247-871-00	CARBON 47K 5%	1/6W	R254	1-247-849-00	CARBON 5.6K 5%	1/6W
R140	1-247-871-00	CARBON 47K 5%	1/6W	R255	1-247-831-00	CARBON 1K 5%	1/6W
R141	1-249-421-11	CARBON 2.2K 5%	1/6W	R301	1-247-833-00	CARBON 1.2K 5%	1/6W
R142	1-247-831-00	CARBON 1K 5%	1/6W	R302	1-247-827-00	CARBON 680 5%	1/6W
R143	1-247-855-00	CARBON 10K 5%	1/6W	R303	1-247-813-00	CARBON 180 5%	1/6W
R144	1-247-855-00	CARBON 10K 5%	1/6W	R304	1-247-821-00	CARBON 390 5%	1/6W
R145	1-247-851-00	CARBON 6.8K 5%	1/6W	R305	1-247-133-00	CARBON 1.2K 5%	1/4W
R146	1-247-863-00	CARBON 22K 5%	1/6W	R306	1-247-855-00	CARBON 10K 5%	1/6W
R147	1-247-823-00	CARBON 470 5%	1/6W	R307	1-247-848-00	CARBON 5.1K 5%	1/6W
R148	1-247-831-00	CARBON 1K 5%	1/6W	R309	1-247-855-00	CARBON 10K 5%	1/6W
R149	1-247-831-00	CARBON 1K 5%	1/6W	R310	1-247-855-00	CARBON 10K 5%	1/6W
R150	1-247-823-00	CARBON 470 5%	1/6W	R311	1-247-875-00	CARBON 68K 5%	1/6W
				R312	1-247-123-00	CARBON 470 5%	1/4W
				R313	1-247-863-00	CARBON 22K 5%	1/6W

For Service Manuals
MAURITRON SERVICES
 8 Cherry Tree Road, Chinnor
 Oxfordshire, OX9 4QY.
 Tel (01844) 351694
 Fax (01844) 352554
 email:- mauritron@dial.pipex.com

B

Ref.No.	Part No.	Description	Remark	Ref.No.	Part No.	Description	Remark
R314	1-247-859-00	CARBON	15K 5% 1/6W	R404	1-247-863-00	CARBON	22K 5% 1/6W
R315	1-247-871-00	CARBON	47K 5% 1/6W	R405	1-247-807-00	CARBON	100 5% 1/6W
R316	1-247-871-00	CARBON	47K 5% 1/6W	R406	1-247-807-00	CARBON	100 5% 1/6W
R317	1-247-879-00	CARBON	100K 5% 1/6W	R407	1-247-107-00	CARBON	100 5% 1/4W
R318	1-247-869-00	CARBON	39K 5% 1/6W	R408	1-247-855-00	CARBON	10K 5% 1/6W
R319	1-247-869-00	CARBON	39K 5% 1/6W	R409	1-247-847-00	CARBON	4.7K 5% 1/6W
R321	1-247-817-00	CARBON	270 5% 1/6W	R410	1-247-847-00	CARBON	4.7K 5% 1/6W
R322	1-247-835-00	CARBON	1.5K 5% 1/6W	R411	1-247-849-00	CARBON	5.6K 5% 1/6W
R323	1-247-831-00	CARBON	1K 5% 1/6W	R412	1-215-463-00	METAL	56K 1% 1/6W
R324	1-247-807-00	CARBON	100 5% 1/6W	R413	1-247-837-00	CARBON	1.8K 5% 1/6W
R325	1-247-815-00	CARBON	220 5% 1/6W	R415	1-247-815-00	CARBON	220 5% 1/6W
R326	1-247-815-00	CARBON	220 5% 1/6W	R416	1-247-881-00	CARBON	120K 5% 1/6W
R327	1-247-833-00	CARBON	1.2K 5% 1/6W	R417	1-247-863-00	CARBON	22K 5% 1/6W
R328	1-247-837-00	CARBON	1.8K 5% 1/6W	R418	1-247-873-00	CARBON	56K 5% 1/6W
R329	1-247-837-00	CARBON	1.8K 5% 1/6W	R419	1-247-865-00	CARBON	27K 5% 1/6W
R330	1-247-871-00	CARBON	47K 5% 1/6W	R420	1-247-885-00	CARBON	180K 5% 1/6W
R331	1-247-867-00	CARBON	33K 5% 1/6W	R421	1-247-875-00	CARBON	68K 5% 1/6W
R332	1-247-843-00	CARBON	3.3K 5% 1/6W	R422	1-247-857-00	CARBON	12K 5% 1/6W
R333	1-247-859-00	CARBON	15K 5% 1/6W	R423	1-247-843-00	CARBON	3.3K 5% 1/6W
R334	1-247-871-00	CARBON	47K 5% 1/6W	R424	1-247-857-00	CARBON	12K 5% 1/6W
R335	1-247-867-00	CARBON	33K 5% 1/6W	R425	1-247-875-00	CARBON	68K 5% 1/6W
R336	1-247-863-00	CARBON	22K 5% 1/6W	R426	1-247-865-00	CARBON	27K 5% 1/6W
R337	1-247-855-00	CARBON	10K 5% 1/6W	R427	1-247-873-00	CARBON	56K 5% 1/6W
R338	1-247-855-00	CARBON	10K 5% 1/6W	R428	1-247-855-00	CARBON	10K 5% 1/6W
R339	1-247-863-00	CARBON	22K 5% 1/6W	R429	1-247-863-00	CARBON	22K 5% 1/6W
R340	1-247-871-00	CARBON	47K 5% 1/6W	R430	1-247-177-00	CARBON	82K 5% 1/4W
R341	1-247-823-00	CARBON	470 5% 1/6W	R431	1-247-849-00	CARBON	5.6K 5% 1/6W
R342	1-249-421-11	CARBON	2.2K 5% 1/6W	R432	1-247-863-00	CARBON	22K 5% 1/6W
R343	1-247-833-00	CARBON	1.2K 5% 1/6W	R433	1-247-891-00	CARBON	330K 5% 1/6W
R344	1-247-835-00	CARBON	1.5K 5% 1/6W	R434	1-247-855-00	CARBON	10K 5% 1/6W
R345	1-247-869-00	CARBON	39K 5% 1/6W	R435	1-247-871-00	CARBON	47K 5% 1/6W
R346	1-247-869-00	CARBON	39K 5% 1/6W	R436	1-247-895-00	CARBON	470K 5% 1/6W
R347	1-247-131-00	CARBON	1K 5% 1/4W	VARIABLE RESISTOR			
R348	1-247-865-00	CARBON	27K 5% 1/6W	RV251	1-230-488-11	RES, VAR, CARBON	10K
R349	1-247-807-00	CARBON	100 5% 1/6W	RV301	1-230-504-11	RES, ADJ, CARBON	220
R350	1-247-867-00	CARBON	33K 5% 1/6W	RV401	1-228-994-00	RES, ADJ, CARBON	10K
R352	1-247-869-00	CARBON	39K 5% 1/6W	RV402	1-228-994-00	RES, ADJ, CARBON	10K
R353	1-246-545-00	CARBON	1M 5% 1/4W	RV403	1-230-487-11	RES, VAR, CARBON	10K
R354	1-247-837-00	CARBON	1.8K 5% 1/6W	RV404	1-230-488-11	RES, VAR, CARBON	10K
R355	1-247-843-00	CARBON	3.3K 5% 1/6W	RV405	1-230-488-11	RES, VAR, CARBON	10K
R356	1-247-887-00	CARBON	220K 5% 1/6W	RV406	1-228-994-00	RES, ADJ, CARBON	10K
R357	1-247-887-00	CARBON	220K 5% 1/6W	RV407	1-230-487-11	RES, VAR, CARBON	10K
R358	1-247-863-00	CARBON	22K 5% 1/6W	RV408	1-230-488-11	RES, VAR, CARBON	10K
R359	1-247-855-00	CARBON	10K 5% 1/6W	RV409	1-230-488-11	RES, VAR, CARBON	10K
R360	1-247-171-00	CARBON	47K 5% 1/4W	SWITCH			
R361	1-247-831-00	CARBON	1K 5% 1/6W	S101	1-516-789-XX	SLIDE SWITCH	
R362	1-247-835-00	CARBON	1.5K 5% 1/6W	S201	1-570-145-11	SWITCH, SLIDE	
R363	1-247-823-00	CARBON	470 5% 1/6W	S301	1-570-145-11	SWITCH, SLIDE	
R364	1-247-823-00	CARBON	470 5% 1/6W				
R365	1-247-827-00	CARBON	680 5% 1/6W				
R401	1-247-813-00	CARBON	180 5% 1/6W				
R402	1-247-813-00	CARBON	180 5% 1/6W				
R403	1-247-813-00	CARBON	180 5% 1/6W				



Ref.No.	Part No.	Description	Remark	Ref.No.	Part No.	Description	Remark
<u>TRANSFORMER</u>							
T301	1-404-584-11	COIL		D603	8-719-300-76	DIODE RH1A	
<u>CRYSTAL</u>							
X301	1-527-789-00	VINRATOR, CRYSTAL		D604	8-719-911-19	DIODE 1SS119	
X302	1-567-413-11	VIBRATOR, CRYSTAL		D605	8-719-911-55	DIODE U05G	

<u>CONNECTOR</u>							
*A-1245-279-A	F BOARD, COMPLETE			F1	*1-506-349-21	3P PLUG (L)	
*****				F2	*1-506-349-21	3P PLUG (L)	
4-365-216-00	SPACER, MICA			F3	*1-508-786-00	2P PLUG (M)	
*4-368-683-01	SPRING			F4	*1-508-767-00	5P PLUG	
<u>CAPACITOR</u>				<u>FUSE</u>			
C601	△ 1-161-738-12	CERAMIC	0.0047MF	20%	400V	F601	△ 1-533-087-11 FUSE, TIME-LAG T3.15A/250V
C602	△ 1-101-821-91	CERAMIC	0.0022MF		500V		1-533-087-00 HOLDER, FUSE; F601
C603	1-123-356-00	ELECT	10MF	20%	50V	<u>IC</u>	
C604	△ 1-161-738-12	CERAMIC	0.0047MF	20%	400V	IC601	8-759-100-75 IC UPC1394C
C605	1-129-709-00	FILM	0.0039MF	10%	630V	<u>COIL</u>	
C606	1-123-384-00	ELECT	10MF	20%	100V	L601	1-407-365-00 COIL, CHOKE
C607	1-102-973-00	CERAMIC	100PF	5%	50V	<u>TRANSISTOR</u>	
C608	1-123-381-00	ELECT	2.2MF	20%	50V	Q601	8-729-245-83 TRANSISTOR 2SC2458
C609	1-101-005-00	CERAMIC	0.022MF		50V	Q602	8-729-195-82 TRANSISTOR 2SC2958
C610	1-123-385-00	ELECT	22MF	20%	100V	Q603	8-729-301-00 TRANSISTOR 2SD1497-02
C611	1-108-688-81	MYLAR	0.0047MF	10%	200V	Q604	8-729-245-83 TRANSISTOR 2SC2458
C612	1-102-030-00	CERAMIC	330PF	10%	500V	<u>RESISTOR</u>	
C613	1-129-709-00	FILM	0.0039MF	10%	630V	R601	1-202-733-00 SOLID 15M 10% 1/2W
C614	1-125-222-21	ELECT(BLOCK)	330MF	20%	400V	R602	△ 1-247-289-11 CARBON 8.2M 5% 1W
C615	1-106-220-00	MYLAR	0.1MF	10%	100V	R603	1-247-829-00 CARBON 820 5% 1/6W
C616	△ 1-161-973-12	CERAMIC	220PF	10%	400V	R604	1-249-421-11 CARBON 2.2K 5% 1/6W
C617	1-106-180-00	MYLAR	0.0022MF	5%	100V	R606	1-247-871-00 CARBON 47K 5% 1/6W
C618	1-123-356-00	ELECT	10MF	20%	16V	R607	1-244-941-00 CARBON 680K 5% 1/2W
C619	1-108-620-91	MYLAR	0.0033MF	10%	100V	R608	1-247-871-00 CARBON 47K 5% 1/6W
C620	1-161-964-00	CERAMIC	0.0047MF		250V	R609	1-246-525-00 CARBON 150K 5% 1/4W
C621	1-161-964-00	CERAMIC	0.0047MF		250V	R610	1-247-863-00 CARBON 22K 5% 1/6W
C622	△ 1-161-964-61	CERAMIC	0.0047MF		250V	R611	1-247-861-00 CARBON 18K 5% 1/6W
C623	△ 1-161-964-61	CERAMIC	0.0047MF		250V	R612	1-246-511-00 CARBON 39K 5% 1/4W
C624	1-130-238-00	FILM	0.22MF	20%	300V	R613	1-247-873-00 CARBON 56K 5% 1/6W
C626	△ 1-130-238-15	FILM	0.22MF	20%	300V	R614	1-214-937-00 METAL 1M 1% 1/2W
C627	1-102-074-00	CERAMIC	0.001MF	10%	50V	R616	1-247-847-00 CARBON 4.7K 5% 1/6W
C628	△ 1-161-738-12	CERAMIC	0.0047MF	20%	400V	R617	1-247-833-00 CARBON 1.2K 5% 1/6W
C629	△ 1-161-738-12	CERAMIC	0.0047MF	20%	400V	R618	1-247-879-00 CARBON 100K 5% 1/6W
C651	1-102-030-00	CERAMIC	330PF	10%	500V	R619	1-247-829-00 CARBON 820 5% 1/6W
C652	1-123-024-00	ELECT	33MF		160V	R620	1-247-815-00 CARBON 220 5% 1/6W
C657	△ 1-161-973-12	CERAMIC	220PF	10%	400V	R621	1-215-896-00 METAL OXIDE 4.7K 5% 2W F
C658	1-102-030-00	CERAMIC	330PF	10%	500V	R622	1-205-687-00 CEMENTED 54K 10% 7W
C659	1-123-335-00	ELECT	330MF	20%	25V		
<u>DIODE</u>							
D601	8-719-101-89	DIODE RD15E-L2					
D602	8-719-101-89	DIODE RD15E-L2					

The components identified by shading and mark **△** are critical for safety. Replace only with part number specified.

Les composants identifiés par une trame et une marque **△** sont critiques pour la sécurité. Ne les remplacer que par une pièce portant le numéro spécifié.

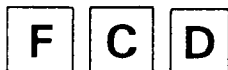

Ref.No.	Part No.	Description	Remark	Ref.No.	Part No.	Description	Remark
R623	1-216-462-00	METAL OXIDE	8.2K 5% 2W F	<u>RESISTOR</u>			
R624	1-205-687-00	CEMENTED	54K 10% 7W	R701	1-202-719-00	SOLID	1M 10% 1/2W
R625	1-247-889-00	CARBON	270K 5% 1/6W	R702	1-202-651-15	SOLID	1.8M 5% 1/2W
R626	1-247-851-00	CARBON	6.8K 5% 1/6W	R703	1-202-649-15	SOLID	1.5M 5% 1/2W
R627	1-207-616-00	WIREWOUND	0.47 10% 2W F	R704	1-202-838-00	SOLID	100K 1/2W
R628	1-247-801-00	CARBON	56 5% 1/6W	R705	1-202-847-00	SOLID	560K 1/2W
R629	1-205-759-11	CEMENTED	680 10% 10W F	R706	1-202-847-00	SOLID	560K 1/2W
R630	1-205-759-11	CEMENTED	680 10% 10W F	R707	1-216-346-00	METAL OXIDE	0.56 5% 1W F
R631	1-205-763-00	CEMENTED	3.3 10% 10W F	R744	1-202-403-37	SOLID	6.8K 10% 1/4W
R632	1-247-863-00	CARBON	22K 5% 1/6W	R745	1-202-403-37	SOLID	6.8K 10% 1/4W
R633	1-247-891-00	CARBON	330K 5% 1/6W	R746	1-202-403-37	SOLID	6.8K 10% 1/4W
R634	1-247-869-00	CARBON	39K 5% 1/6W	<u>VARIABLE RESISTOR</u>			
R635	1-247-891-00	CARBON	330K 5% 1/6W	RV701	1-230-641-11	RES, ADJ, METAL GLAZE	2.2M
R636	1-247-903-00	CARBON	1M 5% 1/6W	RV702	1-230-641-11	RES, ADJ, METAL GLAZE	2.2M
R637	1-247-863-00	CARBON	22K 5% 1/6W	RV703	1-230-798-11	RES, ADJ, METAL GLAZE	90M
R638	1-247-863-00	CARBON	22K 5% 1/6W	*****			
R639	1-247-819-00	CARBON	330 5% 1/6W	*A-1345-538-A	D BOARD, COMPLETE		
R652	1-249-443-11	CARBON	0.47 5% 1/4W F			*****	
<u>VARIABLE RESISTOR</u>				4-363-414-00 SPACER, MICA			
RV601	1-230-627-11	RES, ADJ, CARBON	1K	<u>CAPACITOR</u>			
<u>TRANSFORMER</u>				C501	1-101-004-00	CERAMIC	0.01MF 50V
T601	1-446-194-11	TRANSFORMER, CHOPPER DRIVE		C502	1-123-380-00	ELECT	1MF 20% 50V
T602	1-421-776-11	LFT		C503	1-123-349-00	ELECT	1000MF 20% 35V
T603	1-448-233-11	TRANSFORMER, CONVERTER (SRT)		C504	1-123-369-00	ELECT	4.7MF 20% 50V
T604	1-421-412-11	COIL, FERRITE		C505	1-130-023-00	FILM	0.0027MF 5% 50V
<u>THERMISTOR</u>				C506	1-123-332-00	ELECT	47MF 20% 16V
TH601	1-800-944-00	THERMISTOR TH-4700		C507	1-102-531-00	CERAMIC	150PF 5% 50V
THP601	1-806-165-00	THERMISTOR (POSITIVE)		C508	1-123-380-00	ELECT	1MF 20% 50V
*****				C509	1-123-330-00	ELECT	22MF 20% 16V
*A-1330-619-A	C BOARD, COMPLETE			C510	1-106-224-00	MYLAR	0.15MF 10% 100V
*****				C511	1-123-356-00	ELECT	10MF 20% 16V
1-526-762-00	SOCKET, CRT			C512	1-123-321-00	ELECT	220MF 20% 16V
*4-365-803-00	COVER (MAIN), CV CONTROL			C513	1-102-951-00	CERAMIC	15PF 5% 50V
*4-365-804-00	COVER (REAR LID), CV CONTROL			C514	1-106-220-00	MYLAR	0.1MF 10% 100V
<u>CONNECTOR</u>				C515	1-106-182-00	MYLAR	0.0027MF 10% 100V
C1	*1-508-786-00	2P PLUG (M)		C516	1-123-332-00	ELECT	47MF 20% 16V
<u>CAPACITOR</u>				C517	1-108-630-91	MYLAR	0.022MF 10% 100V
C701	1-102-223-00	CERAMIC	0.0047MF 10% 2KV	C518	1-106-220-00	MYLAR	0.1MF 10% 100V
C702	1-162-116-00	CERAMIC	680PF 10% 2KV	C519	1-136-171-00	FILM	0.33MF 5% 50V
<u>COIL</u>				C520	1-136-171-00	FILM	0.33MF 5% 50V
L702	1-407-697-00	MICRO INDUCTOR	22UH	C551	1-102-244-00	CERAMIC	220PF 10% 500V
L703	1-407-697-00	MICRO INDUCTOR	22UH	C552	1-108-630-91	MYLAR	0.022MF 10% 100V
L704	1-407-697-00	MICRO INDUCTOR	22UH	C553	1-106-196-00	MYLAR	0.01MF 10% 100V
				C554	1-123-345-00	ELECT	100MF 20% 35V
				C555	1-123-335-00	ELECT	330MF 20% 25V
				C556	1-108-622-91	MYLAR	0.0047MF 10% 100V
				C703	1-121-759-00	ELECT	4.7MF 250V
				C704	1-102-110-00	CERAMIC	220PF 10% 50V
				C705	1-102-110-00	CERAMIC	220PF 10% 50V

The components identified by shading and mark Δ are critical for safety. Replace only with part number specified.

Les composants identifiés par une trame et une marque Δ sont critiques pour la sécurité. Ne les remplacer que par une pièce portant le numéro spécifié.

D

Ref.No.	Part No.	Description	Remark	Ref.No.	Part No.	Description	Remark
C706	1-102-110-00	CERAMIC	220PF 10% 50V	C861	1-123-005-00	ELECT 22MF 250V	
C707	1-101-884-00	CERAMIC	56PF 5% 50V	C862	1-102-038-00	CERAMIC 0.001MF 500V	
C708	1-123-333-00	ELECT	100MF 20% 16V	C863	1-102-223-00	CERAMIC 0.0047MF 10% 2KV	
C709	1-161-047-00	CERAMIC	0.0047MF 10% 50V	C868	1-123-321-00	ELECT 220MF 20% 16V	
C710	1-102-074-00	CERAMIC	0.001MF 10% 50V	<u>CONNECTOR</u>			
C711	1-101-888-00	CERAMIC	68PF 5% 50V	D1	*1-560-129-00	PLUG, CONNECTOR (2.5MM) 9P	
C712	1-102-074-00	CERAMIC	0.001MF 10% 50V	D2	*1-508-766-00	4P PLUG (M)	
C713	1-101-884-00	CERAMIC	56PF 5% 50V	D3	*1-560-410-00	PLUG, CONNECTOR (2.5MM) 3P	
C714	1-102-074-00	CERAMIC	0.001MF 10% 50V	D4	*1-564-038-00	CONNECTOR PLUG, DY (MINI) 6P	
C715	1-102-316-00	CERAMIC	15PF 5% 500V	D5	*1-560-290-00	PLUG, CONNECTOR (2.5MM PITCH)	
C716	1-162-549-11	CERAMIC	18PF 5% 500V	D6	*1-508-768-00	6P PLUG	
C717	1-102-316-00	CERAMIC	15PF 5% 500V	D7	*1-560-126-00	PLUG, CONNECTOR (2.5MM) 6P	
C802	1-108-622-91	MYLAR	0.0047MF 10% 100V	D8	*1-508-767-00	5P PLUG	
C803	1-108-627-91	MYLAR	0.012MF 10% 100V	<u>DIODE</u>			
C804	1-123-343-00	ELECT	33MF 20% 35V	D551	8-719-200-02	DIODE 10E2	
C805	1-123-333-00	ELECT	100MF 20% 16V	D552	8-719-911-19	DIODE 1SS119	
C806	1-102-074-00	CERAMIC	0.001MF 10% 50V	D553	8-719-911-19	DIODE 1SS119	
C807	1-123-307-00	ELECT	100MF 20% 10V	D701	8-719-911-19	DIODE 1SS119	
C808	1-123-267-00	ELECT	2.2MF 20% 160V	D702	8-719-911-19	DIODE 1SS119	
C809	1-123-586-00	ELECT	0.1MF 20% 50V	D703	8-719-911-19	DIODE 1SS119	
C810	1-106-196-00	MYLAR	0.01MF 10% 100V	D704	8-719-911-19	DIODE 1SS119	
C811	1-102-038-00	CERAMIC	0.001MF 500V	D705	8-719-911-19	DIODE 1SS119	
C812	1-108-425-00	MYLAR	0.022MF 10% 200V	D706	8-719-911-19	DIODE 1SS119	
C814	1-108-433-00	MYLAR	0.1MF 10% 200V	D707	8-719-911-19	DIODE 1SS119	
C815	△ 1-129-746-51	FILM	0.039MF 10% 400V	D708	8-719-911-19	DIODE 1SS119	
C816	△ 1-162-116-51	CERAMIC	680PF 10% 2KV	D709	8-719-911-19	DIODE 1SS119	
C817	1-102-030-00	CERAMIC	330PF 10% 500V	D710	8-719-300-76	DIODE RH1A	
C818	1-123-379-00	ELECT	0.47MF 20% 50V	D711	8-719-300-76	DIODE RH1A	
C819	△ 1-136-061-11	FILM	0.0078MF 3% 2KV	D712	8-719-300-76	DIODE RH1A	
C820	1-162-116-00	CERAMIC	680PF 10% 2KV	D713	8-719-100-29	DIODE RD5.1E-81	
C821	1-108-627-91	MYLAR	0.012MF 10% 100V	D714	8-719-911-19	DIODE 1SS119	
C822	1-162-116-00	CERAMIC	680PF 10% 2KV	D715	8-719-911-19	DIODE 1SS119	
C823	1-123-318-00	ELECT	33MF 20% 10V	D716	8-719-911-19	DIODE 1SS119	
C824	1-123-318-00	ELECT	33MF 20% 10V	D717	8-719-911-19	DIODE 1SS119	
C825	1-136-116-00	FILM	1MF 5% 200V	D718	8-719-911-19	DIODE 1SS119	
C826	1-136-116-00	FILM	1MF 5% 200V	D719	8-719-911-19	DIODE 1SS119	
C827	1-136-184-00	MYLAR	0.68MF 10% 250V	D802	8-719-911-19	DIODE 1SS119	
C828	1-106-369-00	MYLAR	0.012MF 10% 200V	D804	8-719-200-02	DIODE 10E2	
C829	△ 1-102-038-91	CERAMIC	0.001MF 500V	D805	8-719-200-02	DIODE 10E2	
C830	1-123-307-00	ELECT	100MF 20% 10V	D806	8-719-305-15	DIODE GH3F	
C833	1-162-116-00	CERAMIC	680PF 10% 2KV	D807	8-719-928-08	DIODE ERD28-08	
C841	1-106-196-00	MYLAR	0.01MF 10% 100V	D851	8-719-924-06	DIODE ERC24-06S	
C842	1-102-074-00	CERAMIC	0.001MF 10% 50V	D852	8-719-103-08	DIODE RD13E-N3	
C843	1-123-586-00	ELECT	0.1MF 20% 50V	D854	8-719-924-06	DIODE ERC24-06S	
C844	1-106-182-00	MYLAR	0.0027MF 10% 100V	D855	8-719-901-93	DIODE V19E	
C845	1-123-356-00	ELECT	10MF 20% 16V	D856	8-719-300-65	DIODE ES1F	
C846	1-108-620-91	MYLAR	0.0033MF 10% 100V	D857	8-719-911-19	DIODE 1SS119	
C851	1-123-336-00	ELECT	470MF 20% 25V	<u>IC</u>			
C852	1-102-038-00	CERAMIC	0.001MF 500V	IC501	8-759-915-46	IC TDA2579	
C853	1-101-004-00	CERAMIC	0.01MF 50V		*4-375-717-01	HEAT SINK, IC; IC501	
C854	1-123-024-00	ELECT	33MF 160V				
C859	1-123-382-00	ELECT	3.3MF 20% 50V				
C860	1-123-024-00	ELECT	33MF 160V				

The components identified by shading and mark  are critical for safety. Replace only with part number specified.

Les composants identifiés par une trame et une marque  sont critiques pour la sécurité. Ne les remplacer que par une pièce portant le numéro spécifié.



Ref.No.	Part No.	Description	Remark	Ref.No.	Part No.	Description	Remark
IC551	8-759-113-78	IC UPCI378H-L		R515	1-247-851-00	CARBON	6.8K 5% 1/6W
	4-302-428-00	HEAD, WASHER, TAPPING SCREW; IC551		R516	1-247-805-00	CARBON	82 5% 1/6W
IC801	8-759-905-39	IC TDA1082		R517	1-247-829-00	CARBON	820 5% 1/6W
<u>COIL</u>				R518	1-249-421-11	CARBON	2.2K 5% 1/6W
				R519	1-247-851-00	CARBON	6.8K 5% 1/6W
L701	1-407-697-00	MICRO INDUCTOR 22UH		R520	1-247-871-00	CARBON	47K 5% 1/6W
L801	1-459-060-00	COIL, DYNAMIC CONVERSION CHOKE		R521	1-247-831-00	CARBON	1K 5% 1/6W
L802	1-407-365-00	COIL, CHOKE		R522	1-247-893-00	CARBON	390K 5% 1/6W
L803	1-459-075-00	COIL, DYNAMIC CONVERSION CHOKE		R523	1-247-889-00	CARBON	270K 5% 1/6W
L804	1-459-496-11	COIL, FERRITE (HLC)		R524	1-247-867-00	CARBON	33K 5% 1/6W
L805	1-408-239-00	MICRO INDUCTOR 4.7MMH		R525	1-215-924-00	METAL OXIDE	15K 5% 3W F
L806	1-459-404-00	COIL (WITH CORE)		R526	1-249-421-11	CARBON	2.2K 5% 1/6W
L807	1-459-110-11	COIL, DUST CORE		R527	1-247-891-00	CARBON	330K 5% 1/6W
L809	1-459-060-00	COIL, DYNAMIC CONVERSION CHOKE		R528	1-202-463-95	SOLID	2.2M 5% 1/4W
L851	1-459-215-00	CORE COIL		R530	1-247-887-00	CARBON	220K 5% 1/6W
<u>TRANSISTOR</u>				R531	1-247-875-00	CARBON	68K 5% 1/6W
Q501	8-729-204-83	TRANSISTOR 2SA1048GR		R552	1-215-373-31	METAL	10 1% 1/6W
Q701	8-729-326-11	TRANSISTOR 2SC2611		R553	1-216-455-11	METAL OXIDE	560 5% 2W F
Q702	8-729-326-11	TRANSISTOR 2SC2611		R554	1-247-230-00	CARBON	390 5% 1/2W
Q703	8-729-326-11	TRANSISTOR 2SC2611		R555	1-247-855-00	CARBON	10K 5% 1/6W
Q704	8-729-200-17	TRANSISTOR 2SA1091		R556	1-216-433-00	METAL OXIDE	1.2K 5% 1W F
Q705	8-729-200-17	TRANSISTOR 2SA1091		R708	1-216-486-51	METAL OXIDE	8.2K 5% 3W F
Q706	8-729-200-17	TRANSISTOR 2SA1091		R709	1-247-710-11	CARBON	560 5% 1/4W F
Q707	8-729-326-11	TRANSISTOR 2SC2611		R710	1-216-486-51	METAL OXIDE	8.2K 5% 3W F
Q708	8-729-326-11	TRANSISTOR 2SC2611		R711	1-247-710-11	CARBON	560 5% 1/4W F
Q709	8-729-326-11	TRANSISTOR 2SC2611		R712	1-216-486-51	METAL OXIDE	8.2K 5% 3W F
Q710	8-729-245-83	TRANSISTOR 2SC2458		R713	1-247-710-11	CARBON	560 5% 1/4W F
Q711	8-729-245-83	TRANSISTOR 2SC2458		R714	1-202-561-00	SOLID	330 5% 1/2W
Q712	8-729-245-83	TRANSISTOR 2SC2458		R715	1-202-561-00	SOLID	330 5% 1/2W
Q801	8-729-168-82	TRANSISTOR 2SC2688		R716	1-202-561-00	SOLID	330 5% 1/2W
Q802	8-729-800-35	TRANSISTOR 2SD1397		R717	1-215-926-00	METAL OXIDE	33K 5% 3W F
Q803	8-729-313-42	TRANSISTOR 2SD1134		R719	1-247-167-00	CARBON	33K 5% 1/4W
	*4-323-833-00	HEAT SINK, PIN OUT; Q803		R720	1-214-964-00	METAL	1M 1% 1/4W
Q851	8-729-245-83	TRANSISTOR 2SC2458		R721	1-215-926-00	METAL OXIDE	33K 5% 3W F
Q852	8-729-204-83	TRANSISTOR 2SA1048GR		R723	1-247-167-00	CARBON	33K 5% 1/4W
Q854	8-729-245-83	TRANSISTOR 2SC2458		R724	1-214-958-00	METAL	560K 1% 1/4W
Q861	8-729-245-83	TRANSISTOR 2SC2458		R725	1-215-926-00	METAL OXIDE	33K 5% 3W F
Q862	8-729-313-42	TRANSISTOR 2SD1134		R727	1-247-167-00	CARBON	33K 5% 1/4W
	*4-323-833-00	HEAT SINK, PIN OUT; Q862		R728	1-214-781-00	METAL	150K 1% 1/4W
				R729	1-247-833-00	CARBON	1.2K 5% 1/6W
<u>RESISTOR</u>				R730	1-244-919-00	CARBON	82K 5% 1/2W
R501	1-247-847-00	CARBON	4.7K 5% 1/6W	R731	1-244-919-00	CARBON	82K 5% 1/2W
R503	1-247-859-00	CARBON	15K 5% 1/6W	R732	1-244-919-00	CARBON	82K 5% 1/2W
R504	1-246-545-00	CARBON	1M 5% 1/4W	R733	1-247-855-00	CARBON	10K 5% 1/6W
R505	1-216-349-00	METAL OXIDE	1 5% 1W F	R734	1-247-855-00	CARBON	10K 5% 1/6W
R506	1-247-881-00	CARBON	120K 5% 1/6W	R735	1-247-855-00	CARBON	10K 5% 1/6W
R507	1-247-875-00	CARBON	68K 5% 1/6W	R736	1-247-815-00	CARBON	220 5% 1/6W
R510	1-247-843-00	CARBON	3.3K 5% 1/6W	R737	1-247-805-00	CARBON	82 5% 1/6W
R511	1-247-841-00	CARBON	2.7K 5% 1/6W	R738	1-247-833-00	CARBON	1.2K 5% 1/6W
R512	1-247-821-00	CARBON	390 5% 1/6W	R739	1-247-815-00	CARBON	220 5% 1/6W
R513	1-247-831-00	CARBON	1K 5% 1/6W	R740	1-247-805-00	CARBON	82 5% 1/6W
R514	1-247-835-00	CARBON	1.5K 5% 1/6W	R741	1-247-833-00	CARBON	1.2K 5% 1/6W
				R742	1-247-815-00	CARBON	220 5% 1/6W

The components identified by shading and mark are critical for safety. Replace only with part number specified.

Les composants identifiés par une trame et une marque sont critiques pour la sécurité. Ne les remplacer que par une pièce portant le numéro spécifié.

ACCESSORIES AND PACKING MATERIALS

<u>Part No.</u>	<u>Description</u>	<u>Remark</u>
X-4372-010-1	LEG (LEFT) ASSY, SUPPORT	
X-4372-011-1	LEG (RIGHT) ASSY, SUPPORT	
3-701-631-00	BAG, POLYETHYLENE	
4-372-036-01	BAG, PROTECTION	
4-372-073-01	INDIVIDUAL CARTON	
4-374-024-01	CUSHION (LOWER) (ASSY)	
4-374-025-01	CUSHION (UPPER) (ASSY)	
4-482-110-11	MANUAL, INSTRUCTION	

HARDWARE NOMENCLATURE

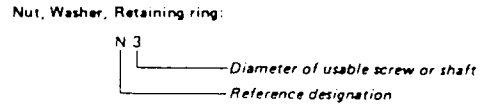
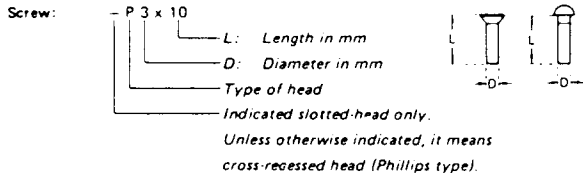

Reference Designation	Shape	Description	Remarks
SCREWS			
P		pan-head screw	binding-head (B) screw for replacement
PWH		pan-head screw with washer face	binding-head (B) screw and flat washer for replacement
PS PSP		pan-head screw with spring washer	binding-head (B) screw and spring washer for replacement
PSW PSPW		pan-head screw with spring and flat washers	binding-head (B) screw and spring and flat washers for replacement
R		round-head screw	binding-head (B) screw for replacement
K		flat-countersunk-head screw	
RK		oval-countersunk-head screw	
B		binding-head screw	
T		truss-head screw	binding-head (B) screw for replacement
F		flat-fillister-head screw	
RF		fillister-head screw	
BV		brazier-head screw	

Reference Designation	Shape	Description	Remarks
SELF-TAPPING SCREWS			
TA		self-tapping screw	ex: TA, P 3 x 10
PTP		pan-head self-tapping screw	binding-head self-tapping (TA, B) screw for replacement
PTPWH		pan-head self-tapping screw with washer face	binding-head self-tapping (TA, B) screw and flat washer for replacement
PTTWH		pan-head thread-rolling screw with washer face	binding-head (B) screw and flat washer for replacement
SET SCREWS			
SC		set screw	
SC		hexagon-socket set screw	ex: SC 2.6 x 4, hexagon socket
NUT			
N		nut	
WASHERS			
W		flat washer	
SW		spring washer	
LW		internal-tooth lock washer	ex: LW3, internal
LW		external-tooth lock washer	ex: LW3, external
RETAINING RINGS			
E		retaining ring	
G		grip-type retaining ring	

NOMENCLATURA DE LA FERRETERÍA

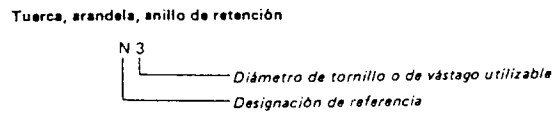
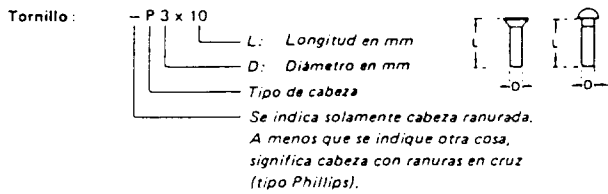

Designación de referencia	Forma	Descripción	Observaciones
TORNILLOS			
P		tornillo de cabeza troncocónica	tornillo de cabeza de sujeción para reemplazo
PWH		tornillo de cabeza troncocónica con cara de arandela	tornillo de cabeza de sujeción y arandela plana para reemplazo
PS PSP		tornillo de cabeza troncocónica con arandela de resorte	tornillo de cabeza de sujeción y arandela de resorte para reemplazo
PSW PSPW		tornillo de cabeza troncocónica y arandelas plana y elástica	tornillo de cabeza de sujeción y arandelas plana y elástica para reemplazo
R		tornillo de cabeza hemisférica	tornillo de cabeza de sujeción para reemplazo
K		tornillo de cabeza embutida plana	
RK		tornillo de cabeza embutida ovalada	
B		tornillo de cabeza de sujeción	
T		tornillo de cabeza hemisférica grande	tornillo de cabeza de sujeción para reemplazo
F		tornillo de cabeza cilíndrica ranurada plana	
RF		tornillo de cabeza cilíndrica ranurada	
BV		tornillo de cabeza tipo braizer	

Designación de referencia	Forma	Descripción	Observaciones
TORNILLOS AUTORROSCANTES			
TA		tornillo autorroscante	ejemplo: TA, P3 x 10
PTP		tornillo autorroscante de cabeza troncocónica	tornillo autorroscante de cabeza de sujeción (TA, B) para reemplazo
PTPWH		tornillo autorroscante de cabeza de sujeción con cara de arandela	tornillo autorroscante de cabeza de sujeción (TA, B) y arandela plana para reemplazo
PTTWH		tornillo laminador de roscas de cabeza troncocónica con cara de arandela	tornillo de cabeza de sujeción y arandela plana para reemplazo
TORNILLOS DE APRIETE			
SC		tornillo de apriete	
SC		tornillo de apriete de hueco hexagonal	ejemplo: SC 2.6 x 4, hueco hexagonal
TUERCA			
N		tuerca	
ARANDELAS			
W		arandela plana	
SW		arandela de resorte	
LW		arandela de presión de diente interno	ejemplo: LW3, interno
LW		arandela de presión de diente externo	ejemplo: LW3, externo
ANILLOS DE RETENCIÓN			
E		anillo de retención	
G		anillo de retención tipo agarre	