

Description

The NEC μPD416 is a 16,384-word by 1-bit dynamic MOS Random-access Memory. It is designed for memory applications where very low cost and large bit storage are important design objectives.

The μPD416 is fabricated using a double-poly-layer, N-channel, silicon-gate process which affords high storage cell density and high performance. The use of dynamic circuitry throughout, including the sense amplifiers, assures minimal power dissipation.

Multiplexed address inputs permit the μPD416 to be packaged in the standard 16-pin dual-in-line package. The 16-pin package provides the highest system bit densities and is available in either ceramic or plastic. Noncritical clock timing requirements allow use of the multiplexing technique while maintaining high performance.

Features

- 16,384-word x 1-bit organization
- High memory density: 16-pin ceramic or plastic packages
- Multiplexed address inputs
- Standard power supplies: +12V, -5V, +5V
- Low power dissipation: 462mw active (max), 20mw standby (max)
- Output data controlled by $\overline{\text{CAS}}$ and unlatched at end of cycle
- Read-modify-write, $\overline{\text{RAS}}$ -only refresh, and page mode capability
- All inputs TTL-compatible and low capacitance
- 128 refresh cycles
- 3 performance ranges:

Device	Access Time	R/W Cycle	RMW Cycle
μPD416-2	200ns	375ns	375ns
μPD416-3	150ns	320ns	320ns
μPD416-5	120ns	320ns	320ns

Pin Configuration

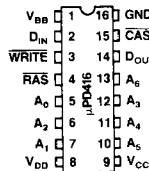

Pin Identification

Pin		
No.	Symbol	Function
1	V _{BB}	-5V power supply
2	D _{IN}	Data-in
3	WRITE	Read/write
4	RAS	Row address strobe
5-7, 10-13	A ₀ -A ₆	Address inputs
8	V _{DD}	+12V power supply
9	V _{CC}	+5V power supply
14	D _{OUT}	Data-out
15	CAS	Column address strobe
16	GND	Ground

Absolute Maximum Ratings*

Operating Temperature, T _{OPR}	0°C to +70°C
Storage Temperature, T _{STG}	-55°C to +150°C
All Output Voltages, V _O ①	-0.5V to +20V
All Input Voltages, V _I ①	-0.5V to +20V
Supply Voltages V _{DD} , V _{CC} , GND ①	-0.5V to +20V
Supply Voltages V _{DD} , V _{CC} ②	-1.0V to +15V
Short-circuit Output Current	50mA
Power Dissipation, P _D	1w

Notes: ① Relative to V_{BB}.
② Relative to GND.

* COMMENT: Exposing the device to stresses above those listed in Absolute Maximum Ratings could cause permanent damage. The device is not meant to be operated under conditions outside the limits described in the operational sections of this specification. Exposure to absolute maximum rating conditions for extended periods may affect device reliability.

Capacitance

T_A = 0°C to +70°C; V_{DD} = +12V ± 10%;
V_{BB} = -5V ± 10%; V_{CC} = +5V ± 10%; GND = 0V

Parameter	Symbol	Limits			Unit	Test Conditions
		Min	Typ	Max		
Input Capacitance (A ₀ -A ₆ , D _{IN})	C _{I1}		4	5	pF	
Input Capacitance (RAS, CAS, WRITE)	C _{I2}		8	10	pF	
Output Capacitance (D _{OUT})	C _O		5	7	pF	



Operational Description

Addressing

The 14 address bits required to decode 1 of 16,384-bit locations are multiplexed on to the 7 address pins and then latched on the chip with the use of the row address strobe ($\overline{\text{RAS}}$), and the column address strobe ($\overline{\text{CAS}}$). The 7-bit row address is first applied and $\overline{\text{RAS}}$ is then brought low. After the $\overline{\text{RAS}}$ hold time has elapsed, the 7-bit column address is applied and $\overline{\text{CAS}}$ is brought low. Since the column address is not needed internally until a time of t_{CRD} max after the row address, this multiplexing operation imposes no penalty on access time as long as $\overline{\text{CAS}}$ is applied no later than t_{CRD} max. If this time is exceeded, access time will be defined from $\overline{\text{CAS}}$ instead of $\overline{\text{RAS}}$.

Data I/O

For a write operation, the input data is latched on the chip by the negative going edge of $\overline{\text{WRITE}}$ or $\overline{\text{CAS}}$, whichever occurs later. If $\overline{\text{WRITE}}$ is active before $\overline{\text{CAS}}$, this is an "early-write" cycle and data-out will remain in the high impedance state throughout the cycle. For a read, write, or read-modify-write cycle, the data output will contain the data in the selected cell after the access time. Data-out will assume the high impedance state anytime that $\overline{\text{CAS}}$ goes high.

Page Mode

The page mode feature allows the μPD416 to be read or written at multiple column addresses for the same row address. This is accomplished by maintaining a low on $\overline{\text{RAS}}$ and strobing the new column address with $\overline{\text{CAS}}$. This eliminates the set-up and hold times for the row address resulting in faster operation.

Refresh

Refresh of the memory matrix is accomplished by performing a memory cycle at each of the 128-row addresses every 2 milliseconds or less. Because data-out is not latched, $\overline{\text{RAS}}$ -only cycles can be used for a simple refresh operation.

Chip Selection

Either $\overline{\text{RAS}}$ and/or $\overline{\text{CAS}}$ can be decoded for chip-select function. Unselected chip outputs will remain in the high impedance state.

Power Sequencing

In order to assure long-term reliability, V_{BB} should be applied first during power-up and removed last during power-down.

Block Diagram

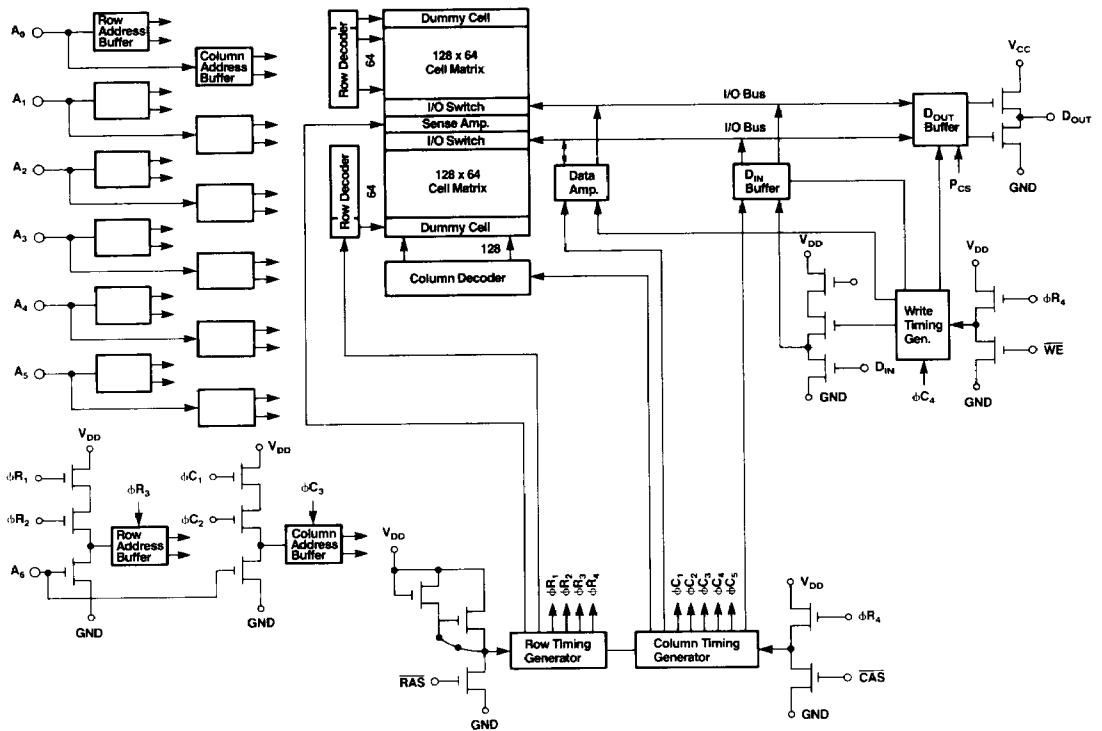

AC Characteristics

T_A = 0°C to +70°C; V_{DD} = +12V ± 10%;
V_{CC} = +5V ± 10%; V_{BB} = -5V ± 10%; GND = 0V

Parameter	Symbol	Limits				Unit	Test Conditions		
		μPD416-2		μPD416-5					
Random Read or Write Cycle Time	t _{RC}	375	320	320	ns	②			
Read-Write Cycle Time	t _{RWC}	375	375	320	ns	②			
Page Mode Cycle Time	t _{PC}	225	170	160	ns				
Access Time from RAS	t _{RAC}	200	150	120	ns	③ ④			
Access Time from CAS	t _{CAC}	135	100	80	ns	④ ⑤			
Output Buffer Turn-off Delay	t _{OFF}	0	50	0	40	35	ns	⑥	
Transition Times (rise and fall)	t _T	3	50	3	35	3	35	ns	⑦
RAS Precharge Time	t _{RP}	120	100	100	ns				
RAS Pulse Width	t _{RAS}	200	32,000	150	32,000	120	10,000	ns	
RAS Hold Time	t _{RSH}	135	100	80	ns				
CAS Pulse Width	t _{CAS}	135	10,000	100	10,000	80	10,000	ns	
RAS to CAS Delay Time	t _{RCD}	25	65	20	50	15	40	ns	⑧
CAS to RAS Precharge Time	t _{CRP}	-20	-20	0	ns				
Row Address Set-up Time	t _{ASR}	0	0	0	ns				
Row Address Hold Time	t _{RAH}	25	20	15	ns				
Column Address Set-up Time	t _{ASC}	-10	-10	-10	ns				
Column Address Hold Time	t _{CAH}	55	45	40	ns				
Column Address Hold Time Referenced to RAS	t _{AR}	120	95	80	ns				
Read Command Set-up Time	t _{RCS}	0	0	0	ns				
Read Command Hold Time	t _{RCH}	0	0	0	ns				
Write Command Hold Time	t _{WCH}	55	45	40	ns				
Write Command Hold Time Referenced to RAS	t _{WCR}	120	95	80	ns				
Write Command Pulse Width	t _{WP}	55	45	40	ns				
Write Command to RAS Lead Time	t _{RWL}	70	50	50	ns				
Write Command to CAS Lead Time	t _{CWL}	70	50	50	ns				
Data-in Set-up Time	t _{DS}	0	0	0	ns	⑨			
Data-in Hold Time	t _{DH}	55	45	40	ns	⑨			
Data-in Hold Time Referenced to RAS	t _{DHR}	120	95	80	ns				
CAS Precharge Time (for page mode cycle only)	t _{CP}	80	60	60	ns				
Refresh Period	t _{REF}	2	2	2	ms				
Write Command Set-up Time	t _{WCS}	-20	-20	0	ns	⑩			
CAS to WRITE Delay	t _{CWD}	95	70	80	ns	⑩			
RAS to WRITE Delay	t _{RWD}	160	120	120	ns	⑩			

- Notes: ① AC measurements assume t_T = 5ns.
 ② The specifications for t_{RC} (min) and t_{RWC} (min) are used only to indicate cycle time at which proper operation over the full temperature range (0°C ≤ T_A ≤ 70°C) is assured.
 ③ Assumes that t_{RCD} ≤ t_{RCD}(max). If t_{RCD} is greater than the maximum recommended value shown in this table, t_{RAC} will increase by the amount that t_{RCD} exceeds the values shown.
 ④ Measured with a load equivalent to 2 TTL loads and 100pF.

- ⑤ Assumes that t_{RCD} ≥ t_{RCD}(max).
 ⑥ t_{OFF}(max) defines the time at which the output achieves the open-circuit condition and is not referenced to output voltage levels.
 ⑦ V_{IHC}(min) or V_{IHL}(min) and V_{IH}(max) are reference levels for measuring timing of input signals. Also, transition times are measured between V_{IHC} or V_{IHL} and V_{IH}.
 ⑧ Operation within the t_{RCD}(max) limit ensures that t_{RAC}(max) can be met. t_{RCD}(max) is specified as a reference point only. If t_{RCD} is greater than the specified t_{RCD}(max) limit, access time is controlled exclusively by t_{CAC}.
 ⑨ These parameters are referenced to CAS leading edge in early write cycles and to WRITE leading edge in delayed write or read-modify-write cycles.
 ⑩ t_{WCS}, t_{CWD} and t_{RWD} are not restrictive operating parameters. They are included in the data sheet as electrical characteristics only. If t_{WCS} ≥ V_{IHC}(min), the cycle is an early write cycle and the data-out pin will remain open circuit (high impedance); if t_{RWD}(min), the cycle is a read-write cycle and the data-out will contain data read from the selected cell. If neither of the above sets of conditions is satisfied the condition of the data-out (at access time) is indeterminate.

DC Characteristics

T_A = 0°C to +70°C; ① V_{DD} = +12V ± 10%;
V_{CC} = +5V ± 10%; V_{BB} = -5V ± 10%; GND = 0V

Parameter	Symbol	Limits			Unit	Test Conditions
		Min	Typ	Max		
Supply Voltage	V _{DD}	10.8	12.0	13.2	V	②
Supply Voltage	V _{CC}	4.5	5.0	5.5	V	② ③
Supply Voltage	GND	0	0	0	V	②
Supply Voltage	V _{BB}	-4.5	-5.0	-5.5	V	②
Input High Voltage (Logic 1), RAS, CAS, WRITE	V _{IHC}	2.7		7.0	V	②
Input High Voltage (Logic 1), (all inputs except RAS, CAS, WRITE)	V _{IH}	2.4		7.0	V	②
Input Low Voltage (Logic 0), (all inputs)	V _{IL}	-1.0		0.8	V	②
Operating V _{DD} Current	I _{DD1}		35		mA	RAS, CAS, cycling; t _{RC} = t _{RC} min ④
Standby V _{DD} Current	I _{DD2}		1.5		mA	RAS = V _{IHC} ; D _{OUT} = high impedance
Refresh V _{DD} Current (μPD416-5)	I _{DD3}		27		mA	RAS cycling; CAS = V _{IHC} ; t _{RC} = 375ns ④
Refresh V _{DD} Current (all speeds except μPD416-5)	I _{DD3}		25		mA	
Page Mode V _{DD} Current	I _{DD4}		27		mA	RAS = V _{IH} ; CAS cycling; t _{PC} = 225ns ④
Operating V _{CC} Current	I _{CC1}				μA	RAS, CAS cycling; t _{RC} = 375ns ⑤
Standby V _{CC} Current	I _{CC2}	-10		10	μA	RAS = V _{IHC} ; D _{OUT} = high impedance
Refresh V _{CC} Current	I _{CC3}	-10		10	μA	RAS cycling; CAS = V _{IHC} ; t _{RC} = 375ns
Page Mode V _{CC} Current	I _{CC4}				μA	RAS = V _{IH} ; CAS cycling; t _{PC} = 225ns ⑤
Operating V _{BB} Current	I _{BB1}		200		μA	RAS, CAS cycling; t _{RC} = 375ns
Standby V _{BB} Current	I _{BB2}		100		μA	RAS = V _{IHC} ; D _{OUT} = high impedance
Refresh V _{BB} Current	I _{BB3}		200		μA	RAS cycling; CAS = V _{IHC} ; t _{RC} = 375ns
Page Mode V _{BB} Current	I _{BB4}		200		μA	RAS = V _{IH} ; CAS cycling; t _{PC} = 225ns
Input Leakage (any input)	I _{IL}	-10		10	μA	V _{BB} = -5V; 0V < V _{IH} < +7V; all other pins not under test = 0V
Output Leakage	I _{OL}	-10		10	μA	D _{OUT} is disabled; 0V ≤ V _{OUT} ≤ +5.5V
Output High Voltage (Logic 1)	V _{OH}	2.4			V	I _{OUT} = -5mA ③
Output Low Voltage (Logic 0)	V _{OL}		0.4		V	I _{OUT} = 4.2mA

- Notes: ① T_A is specified here for operation at frequencies to t_{RC} ≥ t_{RC}(min). Operation at higher cycle rates with reduced ambient temperatures and high power dissipation is permissible, provided AC operating parameters are met. See Figure 1 for derating curve.
 ② All voltages referenced to GND.
 ③ Output voltage will swing from GND to V_{CC} when activated with no current loading. For purposes of maintaining data in standby mode, V_{CC} may be reduced to GND without affecting refresh operations or data retention. However, the V_{OH}(min) specification is not guaranteed in this mode.
 ④ I_{DD1}, I_{DD3}, and I_{DD4} depend on cycle rate. See Figures 2, 3 and 4 for I_{DD} limits at other cycle rates.
 ⑤ I_{CC1} and I_{CC4} depend upon output loading. During readout of high-level data V_{CC} is connected through a low impedance (135Ω typ) to data-out. At all other times I_{CC} consists of leakage currents only.



μ **PD416**

Timing Waveforms

Read Cycle

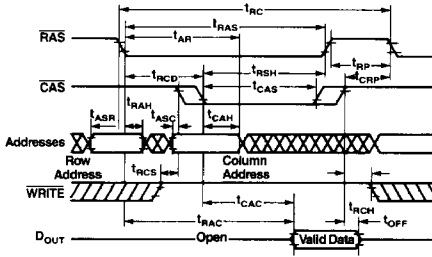

Write Cycle

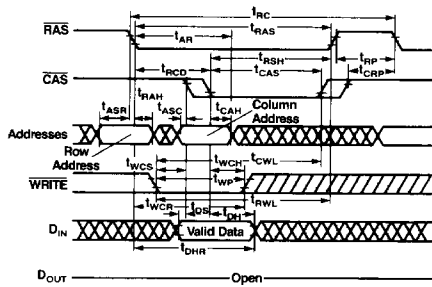

Read-Write/Read-Modify-Write Cycle

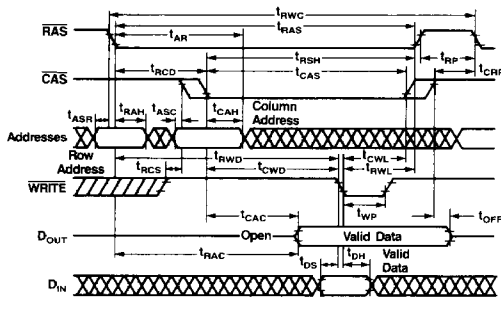

RAS-only Refresh Cycle

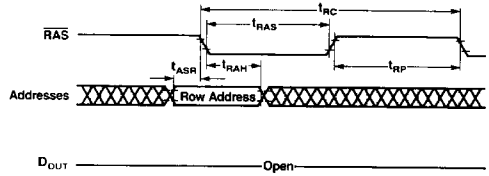

Note: CAS = V_{IH} ; WRITE = Don't care.

Page Mode Read Cycle

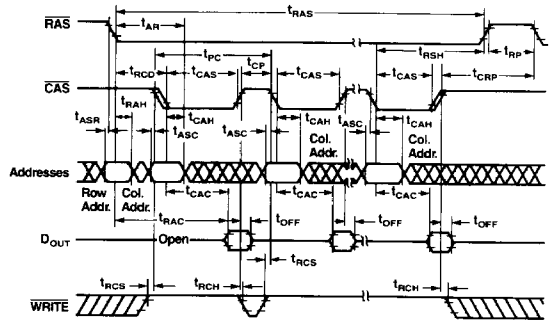

Page Mode Write Cycle

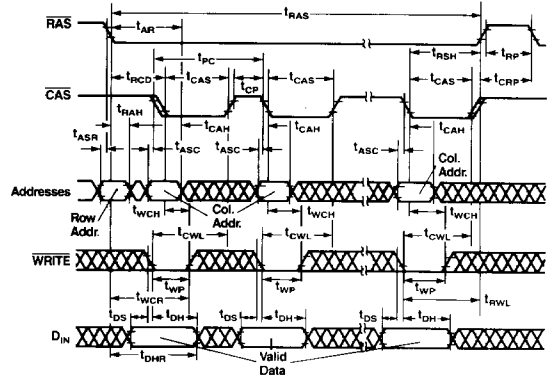

Derating Curves

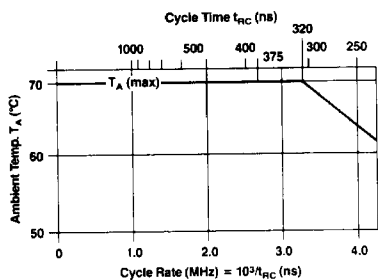

Figure 1. Maximum Ambient Temperature versus Cycle Rate for Extended Frequency Operation

Note: T_A (max) for operation at cycling rates greater than 2.66MHz ($t_{CYC} < 375$ ns) is determined by T_A (max) [°C] = 70 - 9.0 x (cycle rate [MHz] - 2.66). For μPD416-5, it is T_A (max) [°C] = 70 - 9.0 x (cycle rate [MHz] - 3.125).

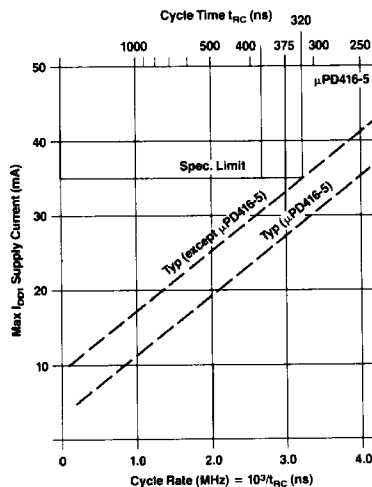

Figure 2. Maximum I_{DD1} versus Cycle Rate for Device Operation at Extended Frequencies

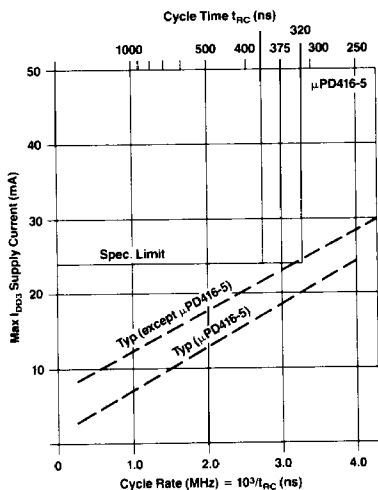

Figure 3. Maximum I_{DD3} versus Cycle Rate for Device Operation at Extended Frequencies

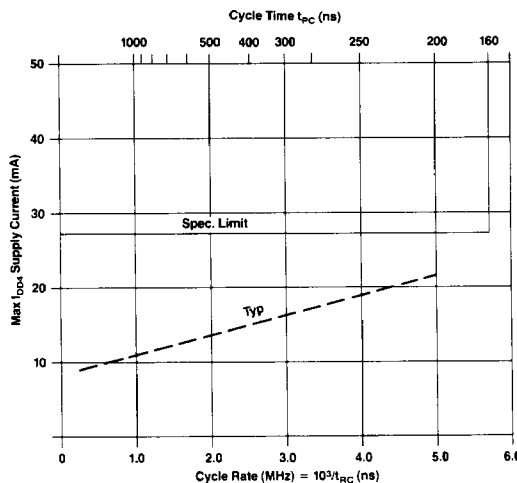

Figure 4. Maximum I_{DD4} versus Cycle Rate for Device Operation in Page Mode

3

Package Outlines

For information, see Section 9.

Plastic, μPD416C
Ceramic, μPD416D