

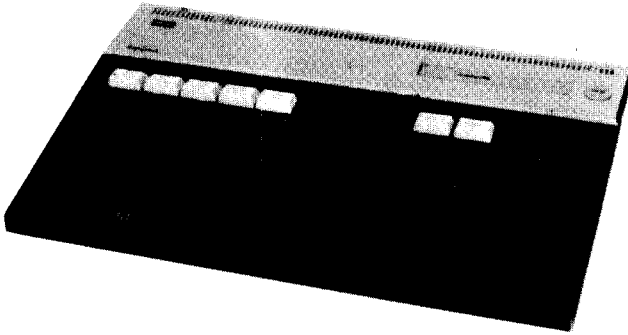

SANYO

MPC-100



MSX PERSONAL COMPUTER OPERATING INSTRUCTIONS

IMPORTANT NOTICE

- The wires in the mains lead are coloured in accordance with the following code.

Green-and-yellow	Earth
Blue	Neutral
Brown	Live

- The wires in the mains lead must be connected to the terminals in the plug as follows.

Wire Color	Plug Terminal Marking
Green-and-yellow	E, ⏏ or green or green-and-yellow
Blue	N or BLACK
Brown	L or RED

This equipment must be protected by a 3A fuse if a 13A (BS1363) plug is used. If another type of plug is used a 5A fuse or lower shall be used, either in the plug or adaptor or at the distribution board.

WARNING! THIS APPARATUS MUST BE EARTHED.

PREFACE

The Sanyo Personal Computer is designed to operate using MSX-BASIC as its language and ROM Cartridges and cassettes are available for various applications. This model is ideal for beginners, wishing to learn about computers, and for those interested in games and children's education, and for all applications both at home and in the office.

This computer includes Operating Instructions and a Programming Manual.

Operating Instructions will explain the connection method of this computer to other equipment.

The Programming Manual in a separate volume provides examples of programming.

Note:

- 1) These Operating Instructions may not be copied or published either in whole or in part without permission of Sanyo.
- 2) These Operating Instruction may be revised or changed with or without notice.
- 3) Sanyo assumes no liability whatsoever for any claim arising from the use of this computer.

MSX is the registered trademark of Microsoft Corp., U.S.A.

TABLE OF CONTENTS

1. Cautions	3
2. Name of Parts	5
3. Connections	7
• Connecting to TV	9
• Connecting to Cassette Tape Recorders	9
• Loading ROM Cartridge	10
• Connecting to Printer	10
• Connecting to Joy Stick	11
• Connecting to Light Pen Unit	11
4. Functional Check	12
5. How to Operate	13
• Keyboard	13
• Familiarise yourself with the Keyboard	18
6. To Save and Load Programs, Use Cassette Tape Recorders	22
• To make Cassette Tape Recorder ready	22
• Loading program onto computer	23
• To save the program	25
• Check to see if the program is properly saved	26
7. Color TV Adjustment	27
8. To Turn off the Power Switch of Computer	27
9. Reset Switch	28
10. Maintenance	28
11. Troubleshooting	29
12. Appendix	31
• Specifications	31
• Terminals Specifications	32
• Memory Map	34

1. CAUTIONS

- If, in an unlikely event, any abnormality is noticed with the computer upon turning the power switch on, such as smoke, odd smells, or noise, unplug the power supply at once and contact the dealer from whom you purchased this unit.

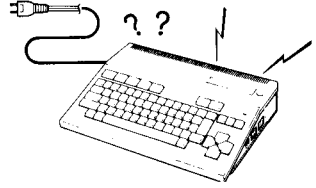

- There are no user serviceable parts inside. Never open the cabinet. This will prevent any electric shock, and damage to this unit.

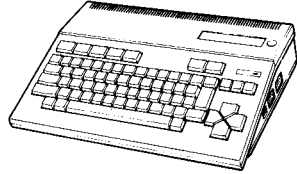

- If the unit fails, send it back to a Sanyo Service Center. Replacement of the power supply cord requires special tools. So do not replace it by yourself for your own safety.

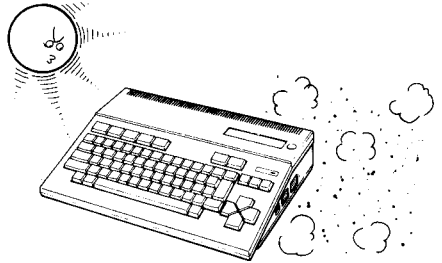

- Avoid locations with high temperature and high humidity, under direct sun light, or with lint or dusts in the atmosphere.

- Keep coffee, tea and soft drinks away from this unit. If any of such liquids are spilled, unplug the power supply, wipe with a soft cloth and at once contact the dealer from whom you purchased this unit.

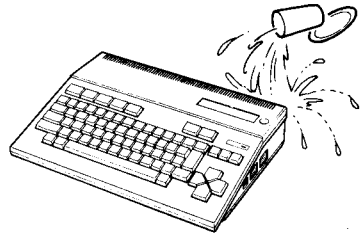

- The maker's name, model No., supply voltage and frequency, and power consumption are indicated on the label stuck at the bottom of the computer cabinet.
- Do not block the vents provided in the cabinet. Do not insert into the vents any metal object such as pins and clips and any inflammable materials. If any of such metal objects should get into any one of the vents, unplug the power supply at once, and contact the dealer from whom you purchased this unit, as this unit can be damaged when used in such conditions.

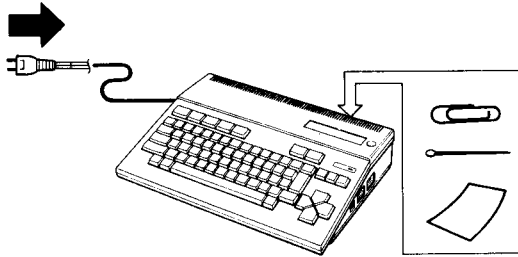

- Do not drop, throw or give any abnormal shock to the unit.

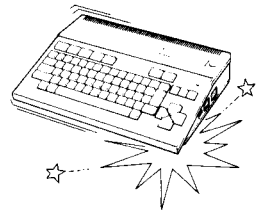

- Do not bend the power supply cord with any excessive strength. Do not place any heavy materials on top of cord.

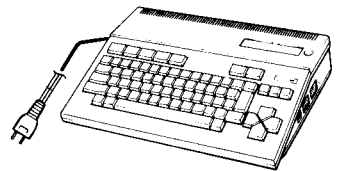

- Unplug the power supply when the unit is not in use for a long period of time.

2. NAME OF PARTS

FRONT TOP

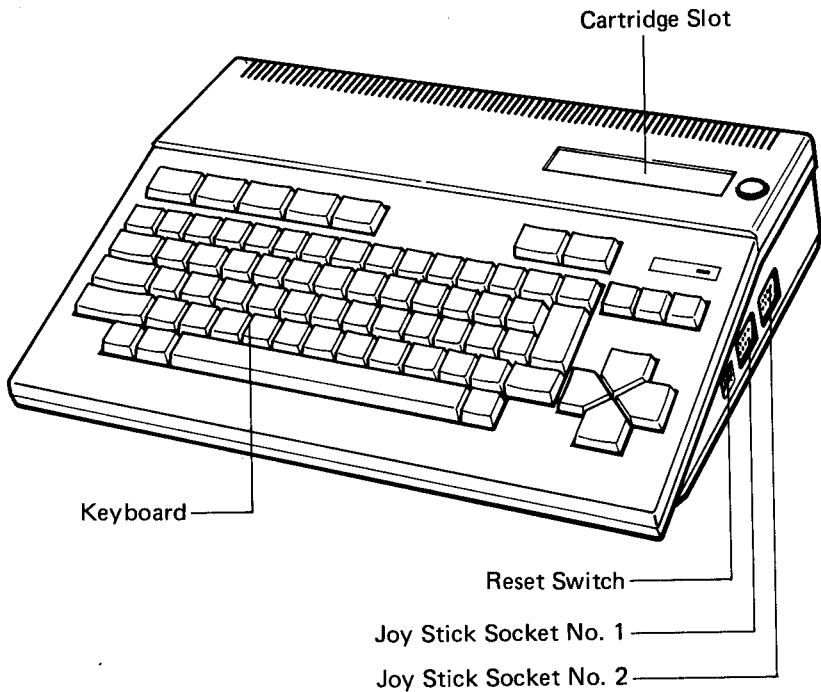

REAR CABINET

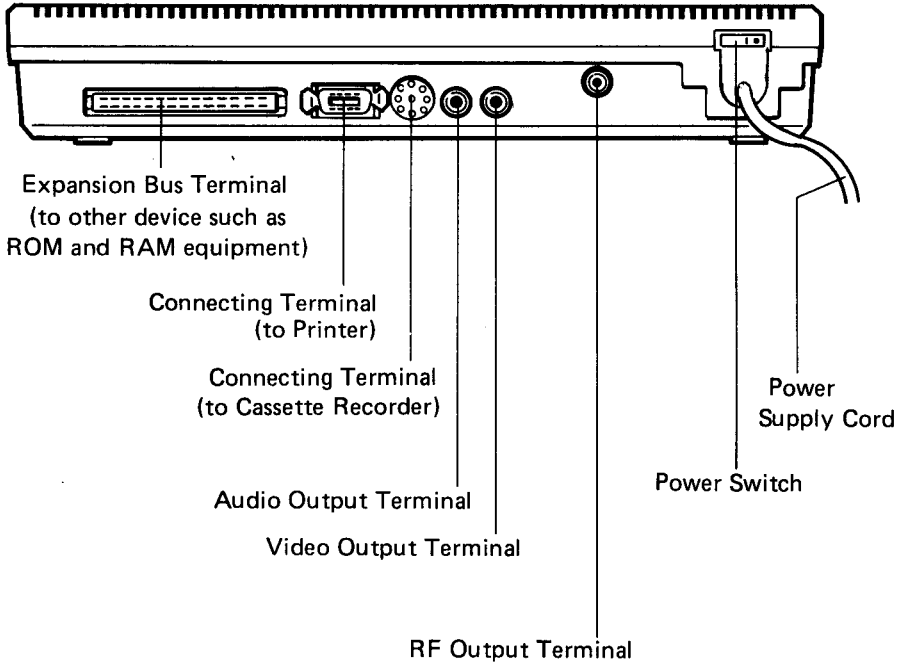

CAUTION: This Expansion Bus is available exclusively for SANYO MSX personal computer.

CONNECTING CABLES (Supplied with the main unit)

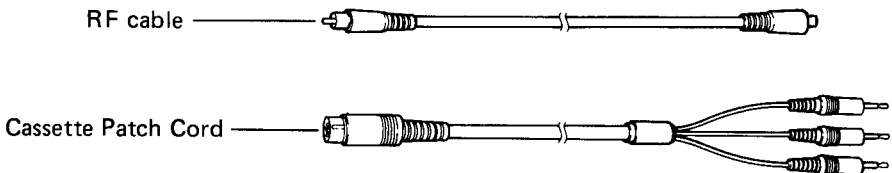

3. CONNECTIONS

Before connecting to this unit, be sure to turn off power switch of each of the peripheral equipments and this unit.

TOP AND RIGHT SIDE

ROM CARTRIDGE
or LIGHT PEN UNIT
(Optional and
separately sold)

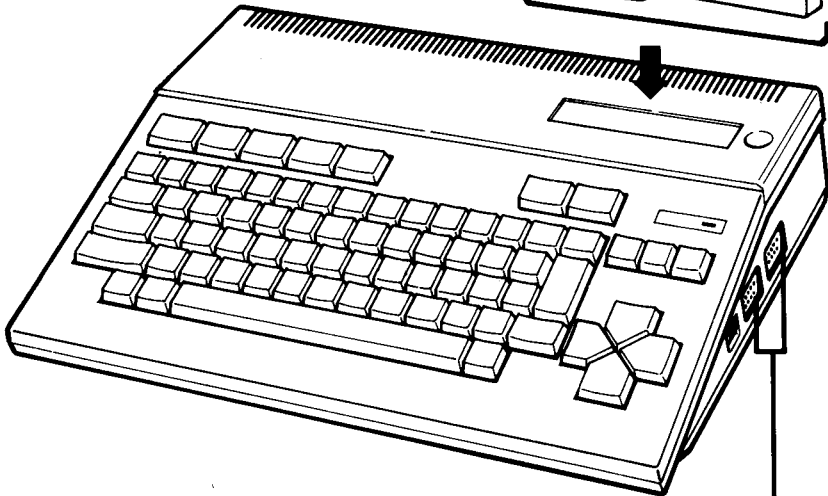
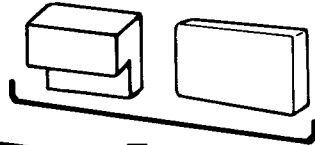

JOY STICK
(Optional and
separately sold)

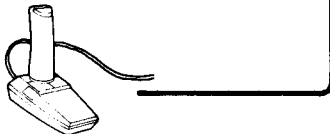

REAR

COLOR TV
(Optional and separately sold)

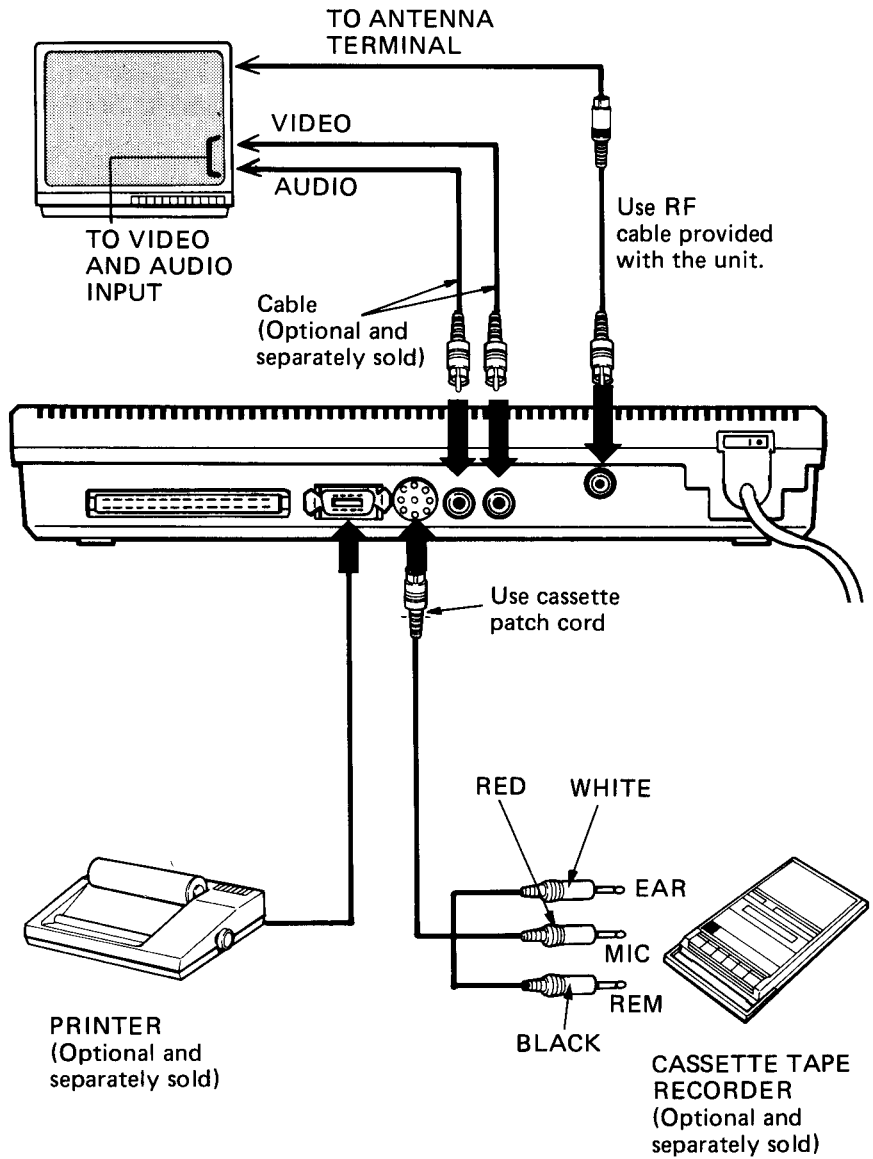

3-1 CONNECTING TO TV

a. Connecting to TV without AUDIO and VIDEO INPUT TERMINALS:

1. Connect RF Output Terminal of computer to Antenna Terminal (75 ohm) of TV Set with RF cable.
2. Set the selected channel of TV until MSX-BASIC prompt appears at top of screen.

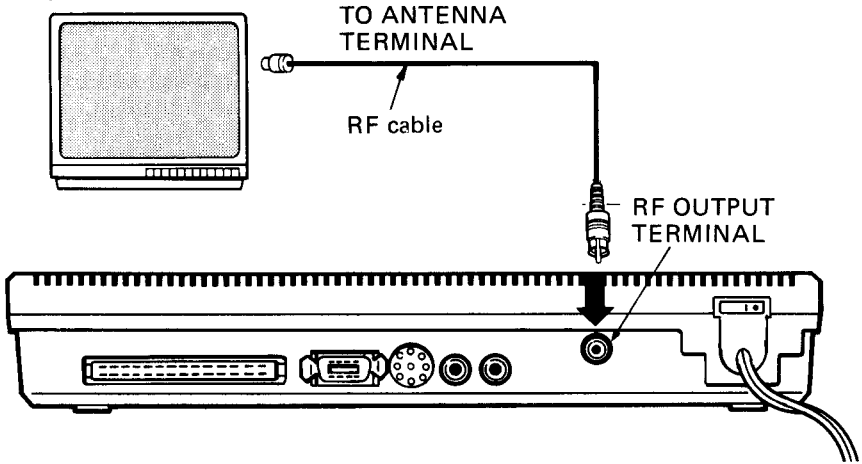

b. Connecting to TV provided with VIDEO and AUDIO INPUT TERMINALS:

Connect VIDEO and AUDIO OUTPUT terminal of computer to both Video and Audio Input Terminals of TV set with cable.

3-2 CONNECTING TO CASSETTE TAPE RECORDERS

Connect this computer to Cassette Tape Recorders with Patch Cords included with unit. If no Remote Control Jack is provided with the Cassette Tape Recorder, do not plug in Remote Jack (Black) with any jack. (In such an instance Start/Stop of Cassette Tape Recorders must be made by hand.)

3-3 LOADING ROM CARTRIDGE

Insert a ROM Cartridge (optional and separately sold) into the slot provided at the top right hand corner of cabinet. The lid for the slot needs not be removed as it will give in inside the slot with the insertion of the ROM Cartridge. Make sure that:

1. To set up a ROM cartridge, keep the cartridge hole to the left and insert the cartridge into the slot.
2. The Cartridge is properly locked into position, in other words, push it down all the way, until a click sound is heard. An improper contact may damage the computer.

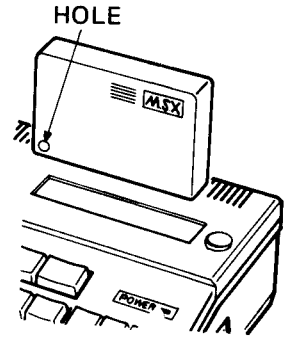

Note:

- This computer will function following the program of the ROM Cartridge. For further details, please consult the Operating Instructions provided with a ROM Cartridge.
- Use only ROM Cartridges bearing the mark of "MSX".

3-4 CONNECTING TO PRINTER

Printers based on the Centronics Specifications (optional and separately sold) can be used with this computer. Please consult with your dealer from whom this unit was purchased as to the most suitable printers available.

Note:

- Use only Connecting Cables having Amphenol type 14-pins.
- The use of an improper connecting cable may result in malfunction.
- Consult also with the Operating Instructions provided with Printer, since certain characters and signs may not be available and thus can be a cause for malfunction.

3-5 CONNECTING TO JOY STICK

- Certain Joy Sticks generally available can be used with this computer. Please consult with the dealer from whom the set was purchased for the proper Joy Sticks to be used with the computer.
- Please also consult with the Operating Instructions provided with ROM Cartridge, etc.

3-6 CONNECTING TO LIGHT PEN UNIT

- You can draw on the TV screen with a light pen. Light pen unit separately available.
- How to use the light pen is referred to in its accompanying instructions.

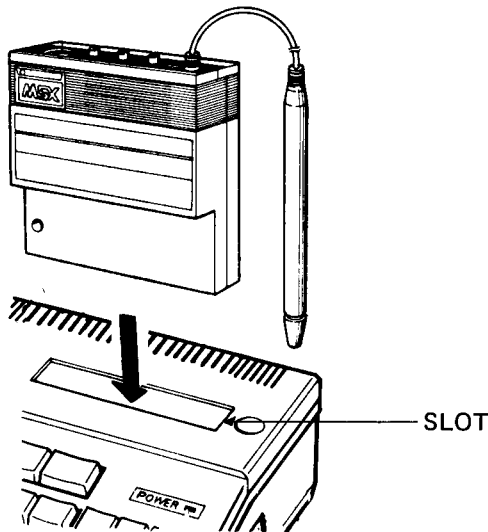

4. FUNCTIONAL CHECK

1. Confirm all connections.

Turn off the Power Switch of all equipment connected to the computer. Check to see if all equipment is properly connected as instructed in page 7 to 8.

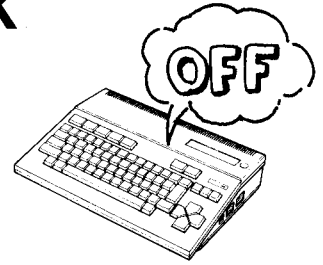

2. Turn on the Power for all peripheral equipment required for the intended operation.

3. Turn on the Power for the computer.

About 4 seconds after the Power Switch of the computer is turned on, the copyright message of MSX-BASIC appears successively in 2 frames. If no message appears or the picture on the screen is unstable, depress the RESET button at the right side of the cabinet. If the computer still does not operate properly, read "Troubleshooting" on page 29. Before turning off the Power Switch, please read "To Turn Off Power Switch" on page 27.

```
MSX BASIC version 1.0
Copyright 1983 by Microsoft
xxxxx Bytes free
Ok
□
```

```
color auto goto list run
```

xxxxx on the screen displays the usable memory expressed in Bytes.

Note:

- Before making the initial functional check of your computer, remove ROM Cartridge from the slot, if it is loaded, since the display on the screen may be affected.
- A small portion of the left and right margins of the screen may be missing with some Television Sets.

5. HOW TO OPERATE

As soon as the message in the preceding page appears, the computer is ready to accept any input of programs which can be transmitted by either of the following methods:

- a. Input via Keyboard,
- b. Input through Cassette, or
- c. Input through ROM Cartridge or Light pen unit.

First of all, familiarise yourself with the Keyboard.

5-1 KEYBOARD

The following characters can be used with the computer through the Keyboard as follows:

Alphabetic Characters	Upper Case: A, B, C, D, ... Lower Case: a, b, c, d, ...
Numeric Characters	0, 1, 2, 3, 4, ...
Special Characters	*, /, +, -, " ...
Graphic Characters	—, ■, ♥, ◆ ...
International Characters	ä, ë, à, á, ... ω, φ, ...

* Be sure to distinguish between the confusingly similar characters, and numbers:

Numbers		1	1
Characters		1	i or I

KEY NAMES

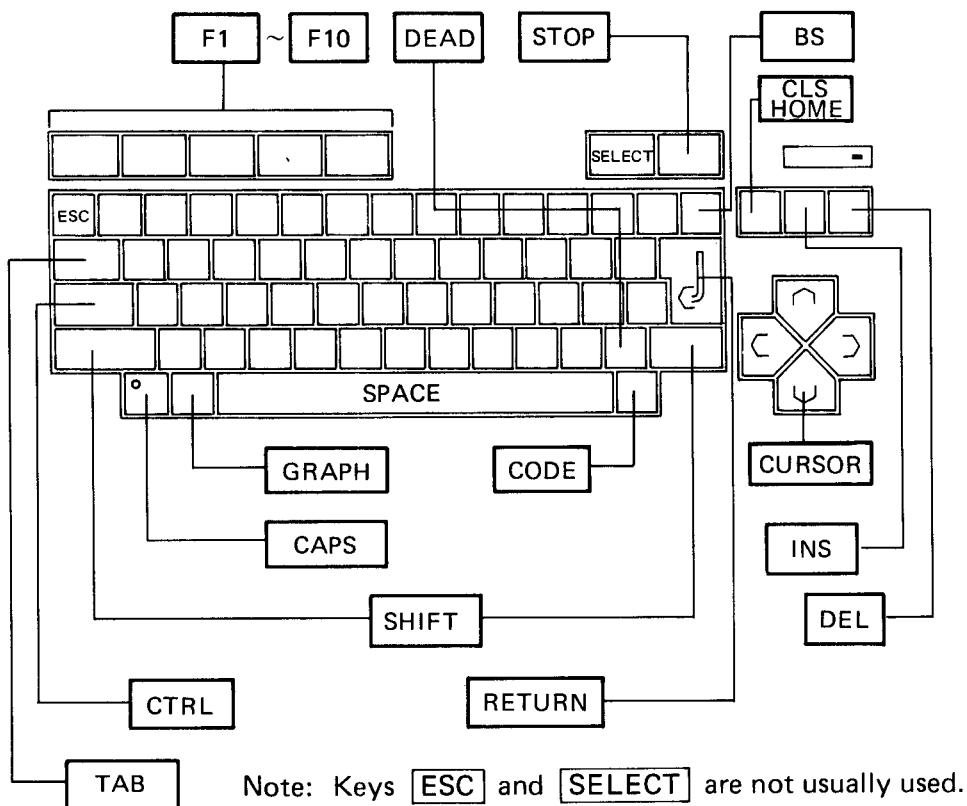

CHARACTERS AND SYMBOLS SET

The **SHIFT**, **CAPS**, **GRAPH** and **CODE** keys serve also to display the following characters and graphic symbols on the screen.

Note:

The mark ⊕ in the key explanation means a toggle key.

Example: **CAPS** ⊕

The mark + denotes that one key is pushed down with its preceding key kept depressed.

Example: **SHIFT** + A

(Push A key while keeping **SHIFT** key down.)

1. NORMAL KEYBOARD

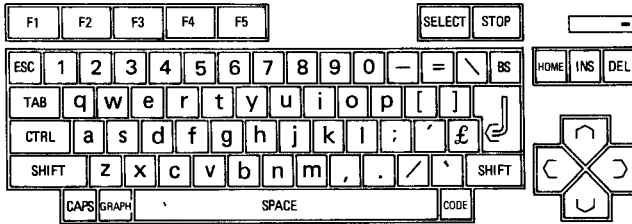

2. SHIFT + ANY KEY

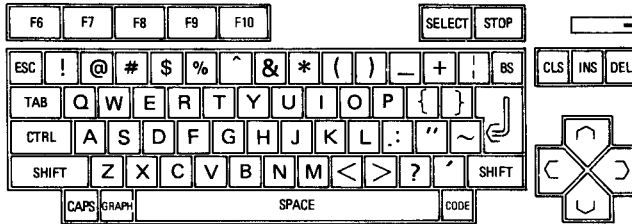

3. CAPS + ANY KEY

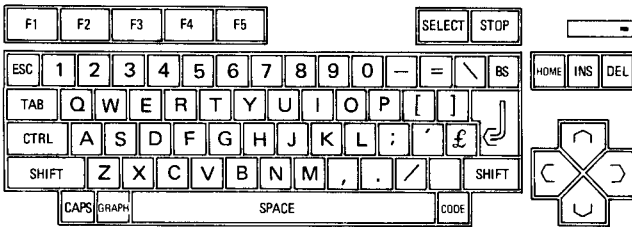

4. GRAPH + ANY KEY

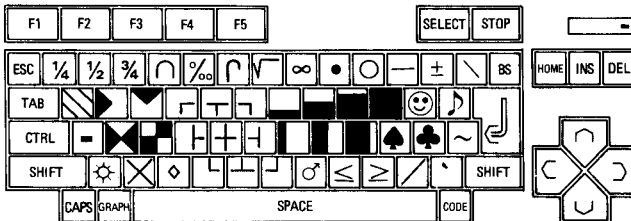

5. **GRAPH** + **SHIFT** + ANY KEY

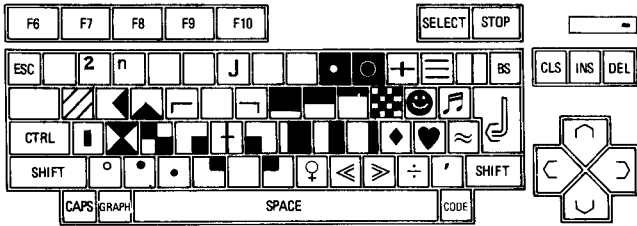

6. **CODE** + ANY KEY

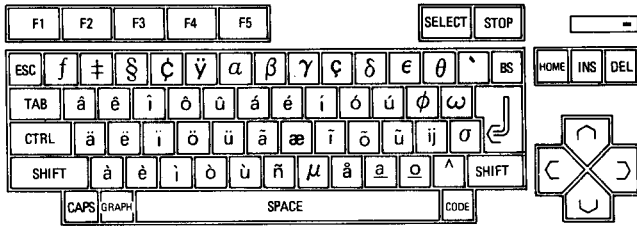

7. **CODE** + **SHIFT** + ANY KEY

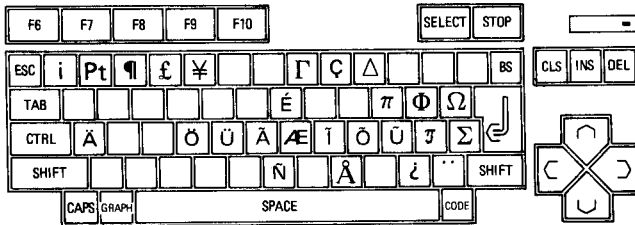

SPECIAL KEYS

CTRL Key — Control Key to control key functions. See Programming Manual.

TAB Key — Tabulation Key to provide a move of 8 spaces.

F1 – **F10** Key — Function Key to command various functions. For further explanation see Note below.

Note:

This computer has 10 pre-defined Function Keys. The current contents of these Keys are displayed on the last line on the screen and can be redefined by program with KEY statement. The initial values for each Key are:

F1	color	F6	color 15, 4, 4
F2	auto	F7	cloud''
F3	goto	F8	cont
F4	list	F9	list.
F5	run	F10	run

(To type f6 through f10, type SHIFT key simultaneously.)

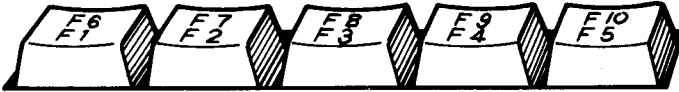

RETURN Key — Press this Key to enable the computer to store in its memory all the inputs displayed on the screen when programming.

DEAD key — Accents and umlaut can be put on by first depressing one or two corresponding keys of **SHIFT**, **GRAPH** and **CODE** and this key, and then pressing the related alphabetical key a, e, i, o, u or y.

Example	Normal (Dead key only)	} è, à
	GRAPH + DEAD		
	SHIFT + DEAD	} é, á
	SHIFT + GRAPH + DEAD		
	CORD + DEAD	 ê, â
	SHIFT + CORD + DEAD	 ë, ä

5-2 FAMILIARISE YOURSELF WITH THE KEYBOARD

First unload ROM the Cartridge from the cartridge slot of the computer (if it is loaded) and turn the Power Switch off on all Peripheral Equipment and then turn the Power Switch on the computer.

- **TYPE CHARACTERS AND SYMBOLS.**

“OK” is now displayed on the last line of the screen.

1. Type, for instance the letter “a” and the cursor moves by one position to the right.

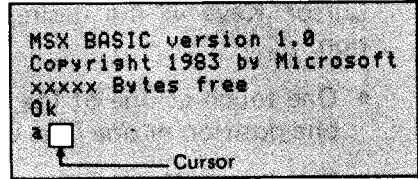

2. Keep typing letters until the cursor reaches the extreme right edge, and automatically the cursor is sent to next line.

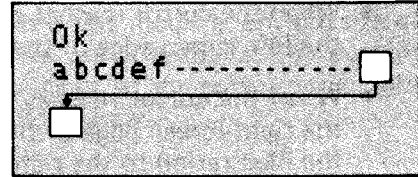

3. If any Key is kept depressed, the input of the same Key is continuously repeated until the Key is finally released.

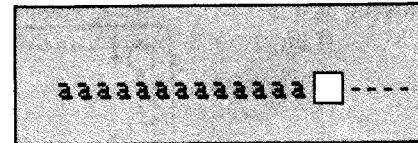

- **TO CLEAR ALL INPUTS ON THE SCREEN:**

Type **[SHIFT]** + **[CLS HOME]** Keys simultaneously. The cursor will go back to Home Position at the upper left corner of the screen.

- **TO ADD, CHANGE AND ERASE ALL TYPES OF CHARACTERS:**

Typing errors made during the program input can be easily corrected. To make a partial correction, move the cursor to the location where correction is necessary.

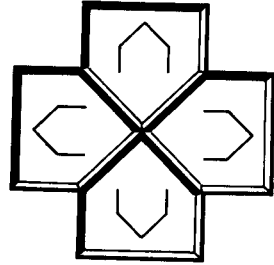

1. **To move the cursor**

To move the cursor, use one of the Cursor Keys in the desired direction.

- One touch at one of the Cursor Keys will move the character by one position or one line, up, down, left or right as desired.
- The Cursor Key will keep the cursor travelling in the direction of the arrow, so long as it is kept depressed.
- When the cursor reaches the right screen edge it will move over to the left screen edge of the next line.
- When the cursor reaches the left screen edge, it will move over to the right screen edge of the penultimate line. For more details see the illustration to the right.

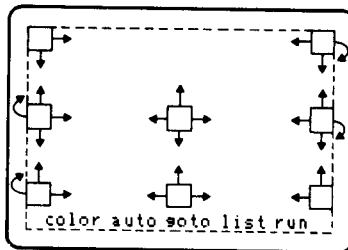

Note:

- The cursor travels only within the width of the display set in text mode by a statement WIDTH.
- The cursor will not travel over the last line of the display where the meanings of each Function Key are displayed.
- **CLS HOME** will move the cursor to the upper left corner of the screen, or Home Position.
- The cursor travels also in any diagonal direction as illustrated to play game programs, etc.

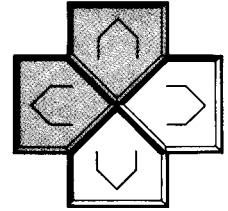

2. To insert characters:

INS ⊕ or **CTRL** + **R** :

Toggle switch for insert mode. When insert mode is on, the size of the cursor is reduced and characters are inserted at the current "Cursor" position. Characters to the right of the cursor move right as new ones are inserted. Line wrap is observed.

Example:

0 1 2 3 **5** 6 To add 4 between 3 and 5, move the cursor
 ↑
 Cursor
 over 5. Type INS once and then type 4.

3. To change characters:

When insert mode is off, the cursor is returned to the normal size and the typed characters will replace existing characters.

Example:

0 1 2 3 **7** 5 6 To change 7 to 4, move the cursor to 7 and
 |
 Cursor
 type 4 over 7.

4. Type **DEL** to delete characters:

Example:

0 1 2 3 **7** 4 5
 ↑
 Cursor

Move the cursor to 7 and type **DEL** to delete 7 and the characters to the right of the cursor move by one position to the left.

5. Type **BS** to delete the character to the left of the cursor:

Example:

0 1 2 3 7 **4** 5
 ↑
 Cursor

Move the cursor to 4 and type **BS** to delete 7 and the characters to the right of the cursor move by one position to the left.

6. Type **SPACE** bar to delete the character without moving the characters to the right of the cursor.

Example

0 1 2 3 **3** 4 5 → 0 1 2 3 **4** 5
 ↑
 Type SPACE bar

7. Type **CTRL** + **E** to delete all characters to the right of the cursor.

0 1 2 **3** 4 5 → 0 1 2 **□**

8. Type **CTRL** + **U** to delete the whole line where the cursor is located.

0 1 3 **4** 5 → **□**

6. TO SAVE AND LOAD PROGRAMS

... USE CASSETTE TAPE RECORDERS

Programs can be saved and loaded using regular Cassette Tape Recorders. Both monaural and stereo are equally fine. One with a remote control jack is preferable since it will permit an automatic operation of cassette tape recorders with the computer command. To avoid errors in the process of saving and loading, however, the use of a Sanyo Data Recorder, which is specifically designed for DATA saving, is recommended.

The importance of this DATA saving function can be well recognized because all the inputs memorized in RAM of the computer are lost the moment the power is turned off, while some of the programs may take hours of hard work for inputs, debuggings, and improvements.

The saving and loading functions of the computer permit the use of programs made by both yourself and others.

6-1 TO MAKE CASSETTE TAPE RECORDER READY

- When the Sanyo Data Recorder is used:

1. Set the thumb wheel volume VOL knob at the maximum position by turning it all the way to the left. (Otherwise, saving failure may result.)

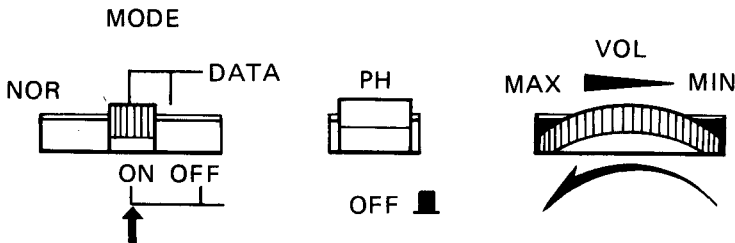

2. Turn off the PH phase switch by setting the push button at HIGH position.
 3. Set the slide switch to DATA mode, either to the ON (for monitor) or OFF (without monitor), whichever is required. Set the Mode switch to the DATA ON position.
- **When a Cassette Tape Recorder other than Data Recorder is used.**
 1. Set the volume control knob around the mid position, neither too low nor too high.
 2. Set the tone control knob (if provided) around the mid position, neither too low nor too high.

6-2 LOADING PROGRAM ONTO COMPUTER

1. Place the cassette tape in the cassette tape recorder.
2. Rewind the cassette all the way to the starting position.
3. Depress the PLAY key. (If the Cassette Tape Recorder is not provided with the remote jack, this STEP must follow after the STEP 4 below.)
4. Type **CLOAD "DEF"** if the program is to be named DEF, and then type return key.
5. With a small "click" sound, the tape starts to run to search for the file name of the commanded program.

6. **FOUND:** will be displayed on the screen. In this search mode, any file other than the one commanded will be identified on the screen as **Skip** followed by the file name.

Example: If the program with the file name of DEF is followed by another one with the file name of ABC, the screen will display:

load "DEF" ← Type input code
Skip : ABC ← In search mode
Found: DEF ← Upon locating the file
Ok
□ ← Cursor

7. Any program saved by means of **CSAVE** can be loaded by typing only **CLOAD**, (Note the quotation mark " must not follow **CLOAD**) if the file name is forgotten or unknown. All preceding file names will be found and loaded one after another by repeating **CLOAD**. Any file programmed in the machine language, saved under **BSAVE** command, cannot be loaded without typing the exact file name.
8. To discontinue search mode, after **CLOAD** is typed in, type **CTRL**+**STOP** simultaneously.
9. Adjust the volume level of the Cassette Tape Recorder between the mid to low range as necessary, if at first attempt at **CLOAD**, the loading is not successful.

6-3 TO SAVE THE PROGRAM

As explained earlier in these Operating Instructions, the program memorized in the RAM of the computer can be erased easily if:

- a. Power Switch is turned off,
- b. Reset Button is depressed once, or
- c. NEW command is typed in,

To save the program, follow the steps specified hereunder:

1. Set a blank cassette tape (other than the tapes provided with this computer) into the Cassette Tape Recorder in position.
2. Set it to recording mode by depressing PLAY and RECORD buttons, or as otherwise instructed in the Operating Instructions of the Cassette Tape Recorder. (If the cassette Tape Recorder is not provided with the remote jack, this STEP must follow after the STEP 4 below.)
3. Type **CSAVE "MSX"** if the program is to be named MSX, or any other file name desired, and then press the return key ().
4. With a small "click" sound, the tape starts to run to save the program.
5. **Ok** will be displayed on the screen and the cassette will stop running. (If the Cassette Tape Recorder is not provided with remote jack, stop it manually when Ok appears.)

```
CSAVE "MSX"
```

```
Ok
```



6. To make an additional back up file, type as follows: In this example, when the program with the file name of "DEMO" is found, and a blank cassette is replaced with the cassette containing "DEMO", the file "DEMO" will then be saved on the blank cassette under the file name of "MSX").

```
cload "DEMO"
```

```
Found : DEMO
```

```
Ok
```

```
csave "MSX"
```

```
Ok
```



6-4 CHECK TO SEE IF THE PROGRAM IS PROPERLY SAVED:

While the program is still stored in the RAM of the computer, it is possible to check whether the program is properly saved by giving **CLOAD?** command as follows:

1. Rewind the cassette tape to the position where saving for the file was started.
2. Suppose the file name just saved is "FLOWER", Type **CLOAD?** "FLOWER" and . Please note that up to six characters can be used for the file name, excepting colon (:) and all other characters identified under character code 0 and 255. See Programming Manual for further details.
3. Depress the PLAY button of the Cassette Tape Recorder. (If the Cassette Tape Recorder is not provided with the remote jack, this STEP must follow after the STEP 4 below.)
4. Type . The cassette tape starts running and the programs stored in memory of the computer and on the cassette tape are compared all the way step by step.
5. Ok will appear on the display if the program is properly saved, and **Verify error** if any difference is noted. If the latter is the case, repeat the CSAVE process one more time by adjusting the volume level of the Cassette Tape Recorder either up or down slightly.

Remarks: The user of the computer should not be frightened with any Error message which is caused by input errors and which appears on the display since no error can damage or destroy the computer. If the input is corrected, it will resume functioning again. See Programming Manual for more details.

7. COLOR TV ADJUSTMENT

Color quality can be affected greatly by how the tint and color of Color TV set are adjusted. Use the color pattern and adjust the tint and color to the optimum settings.

When the power switch is turned on, the background and the border are automatically set in dark blue and the foreground (alphanumeric characters) in white.

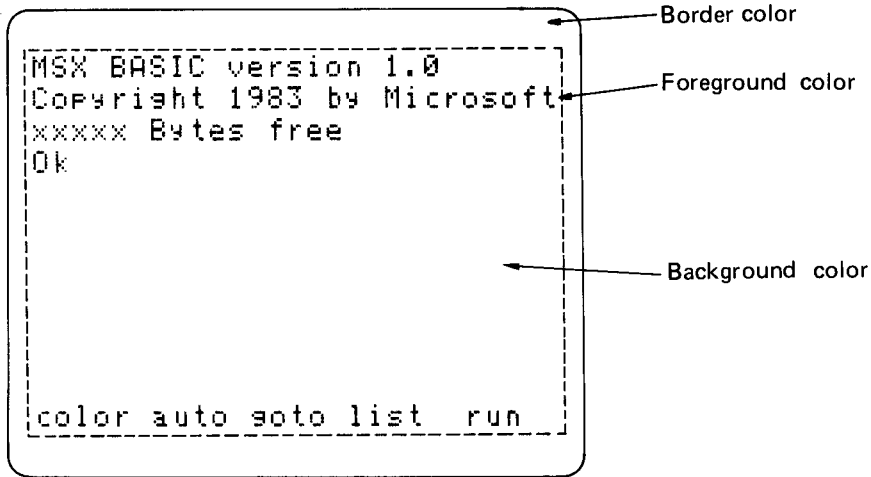

8. TO TURN OFF THE POWER SWITCH OF THE COMPUTER

- 1) First save the program stored in RAM memory of the computer, as the moment the power switch is turned off, it will be lost completely.
- 2) Turn off the power switch of the computer, before all other power switches of peripheral equipment are turned off.
- 3) Do not repeat on/off operations of the power switches of computer and its peripheral equipment at short, quick intervals as it may result in malfunctions.

9. RESET SWITCH

The reset switch is located at the right side of the cabinet. One push of this reset switch will result in:

- 1) The loss of all memory of the program stored in RAM of the computer.
- 2) The same copyright statement (as is displayed on the screen when the power switch is first turned on) appears, if not connected to other devices, such as ROM and RAM Cartridges.
- 3) If connected to other devices, such as ROM and RAM Cartridge, the initial position is resumed.

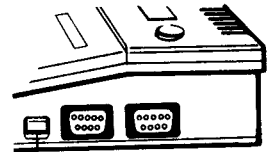

RESET SWITCH

10. MAINTENANCE

- Use soft cloth to wipe stains and dust off the cabinet of the computer.
- Use soft cloth moistened with detergent for removing the stubborn stains and then wipe the surface with dry soft cloth.
- Do not use thinners, benzenes, and other chemical solvents.

11. TROUBLESHOOTING

If by any chance your computer should fail to operate, go through the following check list and make your own diagnosis.

NO PICTURE:

- a. Check to see if the power supply pilot lamp is lit. If not, check the connection to the power outlet.
- b. Check to see if the power is turned on for your television set.
- c. Check to see if the video output or RF output connections are correctly made.
- d. Check to see if a ROM cartridge (if loaded) is properly loaded. Unload it first and load it again.
- e. Check to see if the brightness and contrast controls are set at optimum positions (for RF connection).

THE PICTURE ROUS, OR INPUT SIGNAL IS WEAK.

- a. Check to see the input signal channel of the television set and output signal channel of the computer are correctly matched to the same channel number. (for RF connection)
- b. Adjust the fine tuning control of the television set. (for RF connection)
- c. Adjust horizontal and vertical holds of the television set.
- d. Check to see if the video connecting cable is correctly plugged in to the television set.

ROM CARTRIDGE
FAILS TO
OPERATE.

- a. Check to see if the ROM cartridge is locked into position ALL the way, correctly.
- b. Check to see if the terminals of the ROM cartridge are clean.
- c. Press the Reset Button at the right side of cabinet.

COMPUTER
CEASED TO OPER-
ATE DURING USE.

- a. Power could have been temporarily cut off for a brief moment.
- b. Noise from other electrical equipment could have entered the computer.
- c. Check to see if the peripheral equipment such as printers and cassette tape recorders are correctly connected to the computer.
- d. Check to see if there is no error in the program.

LOADING OR
SAVING USING
CASSETTE TAPE
RECORDER FAILS.

- a. Check to see if the patch cord is correctly connected at both ends.
- b. Check to see if the operation is correctly made as specified in Section 6.
- c. Check to see if the batteries are fresh and not worn out.
- d. Adjust the tone and the volume levels of cassette tape recorder.
- e. Loading from the cassette tape saved in 2400 baud can only be made with cassette tape recorders designed for DATA processing such as Sanyo Data Recorder.

12. APPENDIX

12-1 SPECIFICATION

CPU	Z-80A Compatible (3.58 MHz)
Memory	MAIN MEMORY: 64 KB RAM SYSTEM MEMORY: 32 KB ROM VIDEO MEMORY: 16 KB RAM
Display	Text I : 24 Lines x 40 Characters, 16 colors Text II : 24 Lines x 32 Characters, 16 colors Graphic : 256 x 192 dots, 16 colors Multi Color : 64 x 48 blocks, 16 colors
Sound	3 Sound Channels, 8 octaves
Keyboard	73 Keys
Interface	Printer : 8 bit parallel Cassette : FSK Type, 1,200/2,400 bauds Joystick : 2 slots Cartridge Bus : 1 slot, 50 pin Expansion Bus : 1 slot, 50 pin
Output signal	Video 1.0 VP-P, 75 ohms, RCA phono jack Audio 1.26 VP-P, 600 ohms, RCA phono jack RF (UHF CH36, 591.25 MHz) RCA phono-DIN 75 ohms plug
Dimensions	Cabinet : W385 x H62 x D242 (mm)
Weight	Net weight : 2.2 Kg
Power Supply	240 Volts \pm 10%, AC 50/60 Hz
Power Consumption	11 watts

ACCESSORIES

- RF cable
- Patch Cord for connecting to cassette tape recorder
- Operating Instructions
- Programming Manual
- Cassette Tape . . . 2 pcs.

12-2 TERMINALS SPECIFICATIONS

● Cassette Tape Recorder Terminal

Pin No.	Name		Pin Connection
1	GND	—	
2	GND	—	
3	GND	—	
4	CMTOUT	Output	
5	CMTIN	Input	
6	REM+	Output	
7	REM-	Output	
8	GND	—	

● Printer Terminal

Pin No.	Name	Pin Connection
1	PSTB	
2	PDB0	
3	PDB1	
4	PDB2	
5	PDB3	
6	PDB4	
7	PDB5	
8	PDB6	
9	PDB7	
10	NC	
11	BUSY	
12	NC	
13	NC	
14	GND	

● Joy Stick Terminal

Pin No.	Name		Pin Connection
1	FWD	Input	
2	BACK	Input	
3	LEFT	Input	
4	RIGHT	Input	
5	+5V	—	
6	TRG1	Output	
7	TRG2	Output	
8		Output	
9	GND	—	

• ROM Cartridge Slot/Expansion Bus

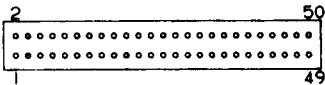
Pin No.	Name	Pin Connection
1	CS1	(Expansion Bus) 
2	CS2	
3	CS12	
4	SLTSL	
6	RF SH	
7	WAIT	
8	INT	
9	MI	
10	BUSDIR	
11	IORQ	
12	MERQ	
13	WR	
14	RD	
15	RESET	
17~32	A0~A15	
33~40	D0~D7	
41	GND	
42	CLOCK	
43	GND	
44, 46	SW1, SW2	
45, 47	+5V	
48	+12V	
49	SUNDIN	
50	-12V	

12-3 MEMORY MAP

